

Functional Group:
 Products : Manifolds : Sandwich : Flow Control : ISO 03 : Meter in P

Model:
 GBP

Face : 6

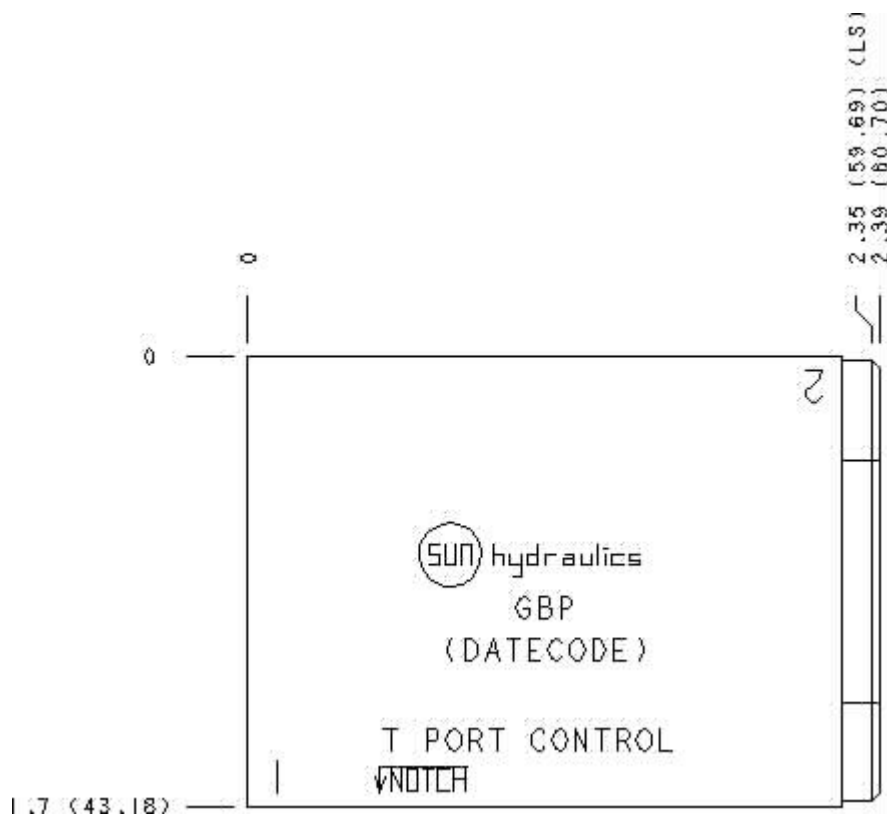

Cartridge extension measurement is to the centerline of the cartridge.

Function

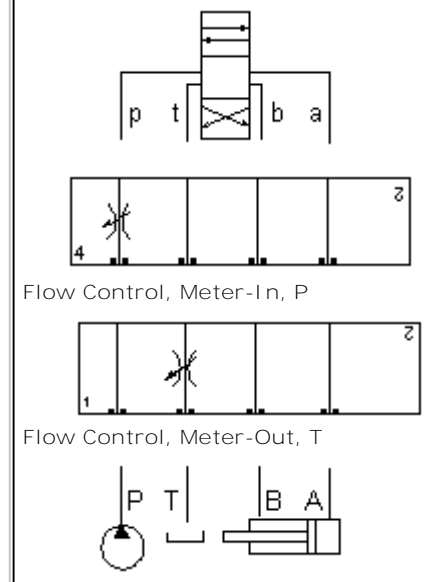

Aluminum Body Pressure Rating: **3000 psi (210 bar)**
 Ductile Iron Body Pressure Rating: **5000 psi (350 bar)**

Technical Data

	U.S. Units	Metric Units
Model Weight	0.58 lb.	0.26 kg.
Cavity	T-13A	
Body Features	Into P or out of T	
Body Type	Sandwich	
Interface	ISO 03	
Open Cavity Quantity	1	
Stack Height	1.75 in.	44,5 mm

Option Selection:

Model Code	Description
GBP	Aluminum, Buna-N, U.S. Units
GBP/S	Ductile Iron, Buna-N, U.S. Units
GBP/V	Aluminum, Viton, U.S. Units
GBP/Y	Ductile Iron, Viton, U.S. Units

Special Notes :

No Special Notes available for selected Model.



Functional Group:
Products : Manifolds : Sandwich : Flow Control : ISO 03 : Meter in P

Model:
GBP

Face : 2

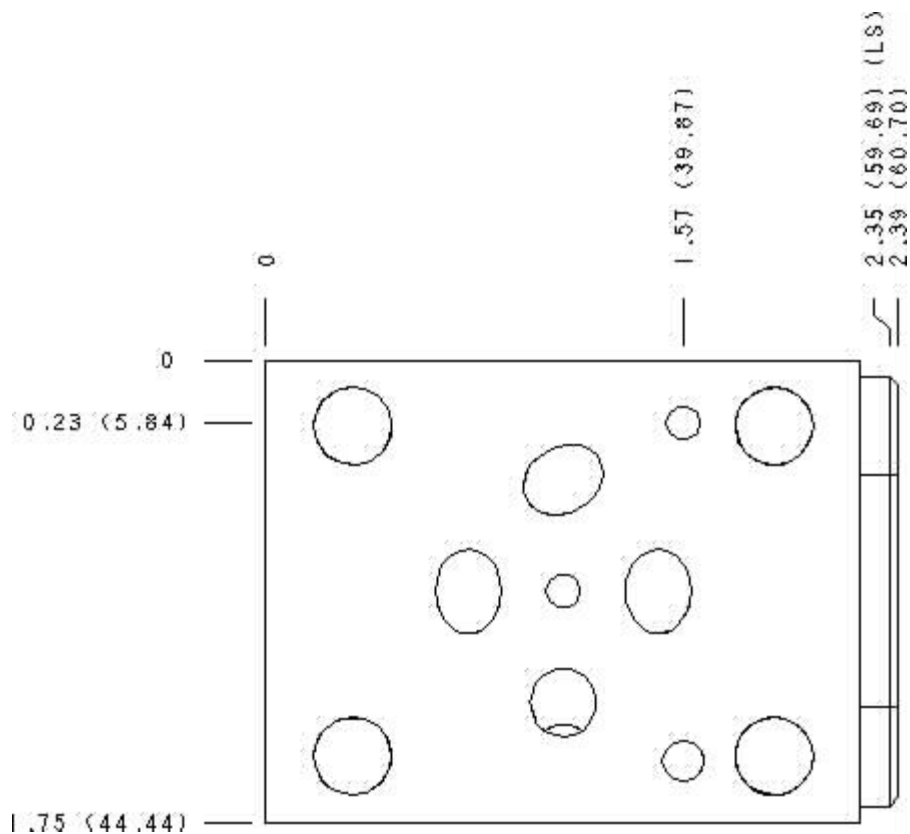

Cartridge extension measurement is to the centerline of the cartridge.



Functional Group:
Products : Manifolds : Sandwich : Flow Control : ISO 03 : Meter in P

Model:
GBP

Face : 7

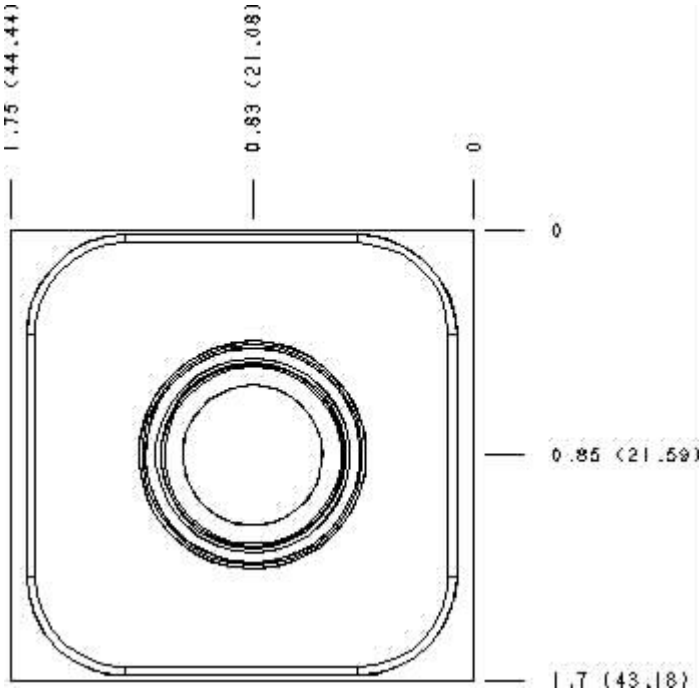

Cartridge extension measurement is to the centerline of the cartridge.



Functional Group:
Products : Manifolds : Sandwich : Flow Control : ISO 03 : Meter in P

Model:
GBP

Face : 8

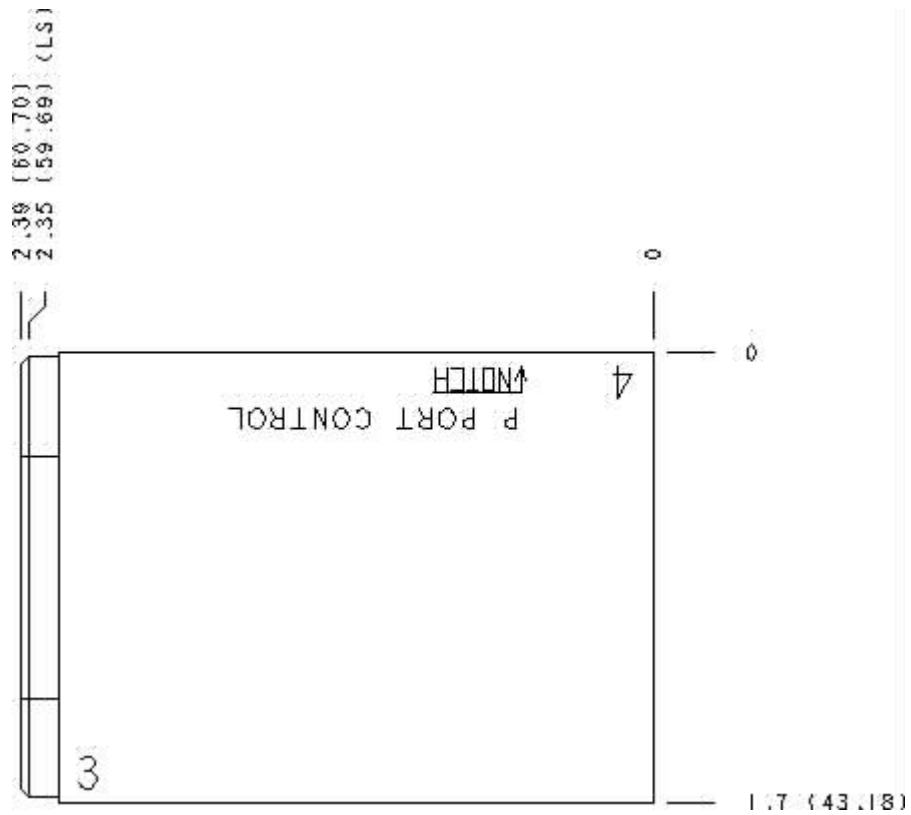

Cartridge extension measurement is to the centerline of the cartridge.



Functional Group:
 Products : Manifolds : Sandwich : Flow Control : ISO 03 : Meter in P

Model:
 GBP

Face : 10

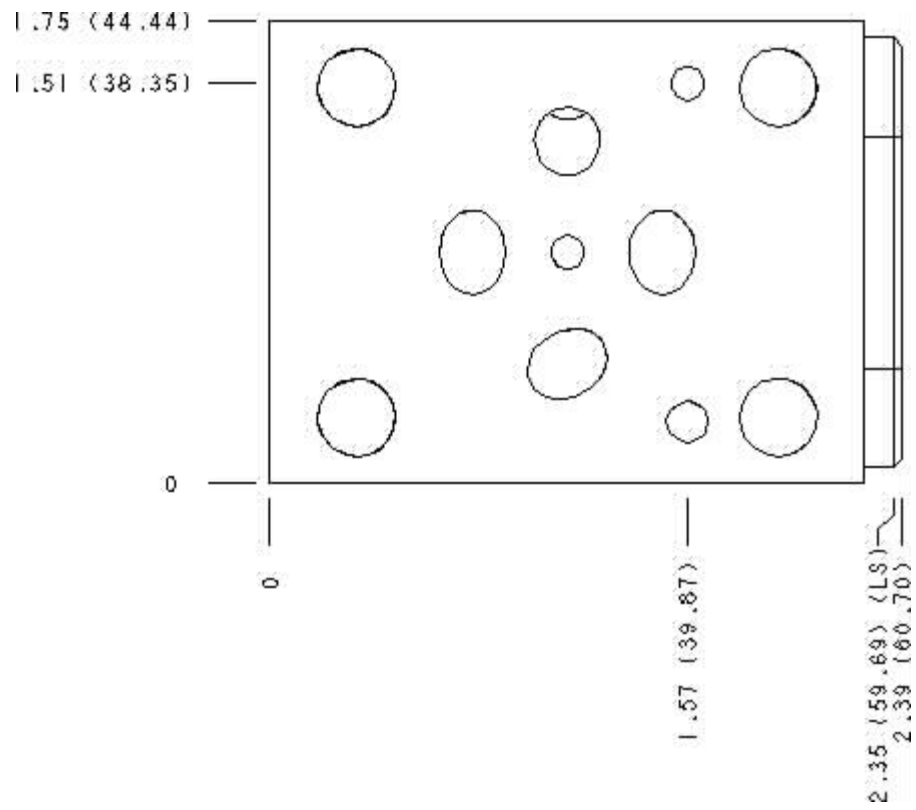

Cartridge extension measurement is to the centerline of the cartridge.



Functional Group:

Products : Manifolds : Sandwich : Flow Control : ISO
03 : Meter in P

Model:
GBP

Projection Type

All Dimensions in Inches(mm)

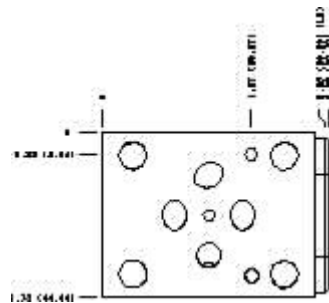

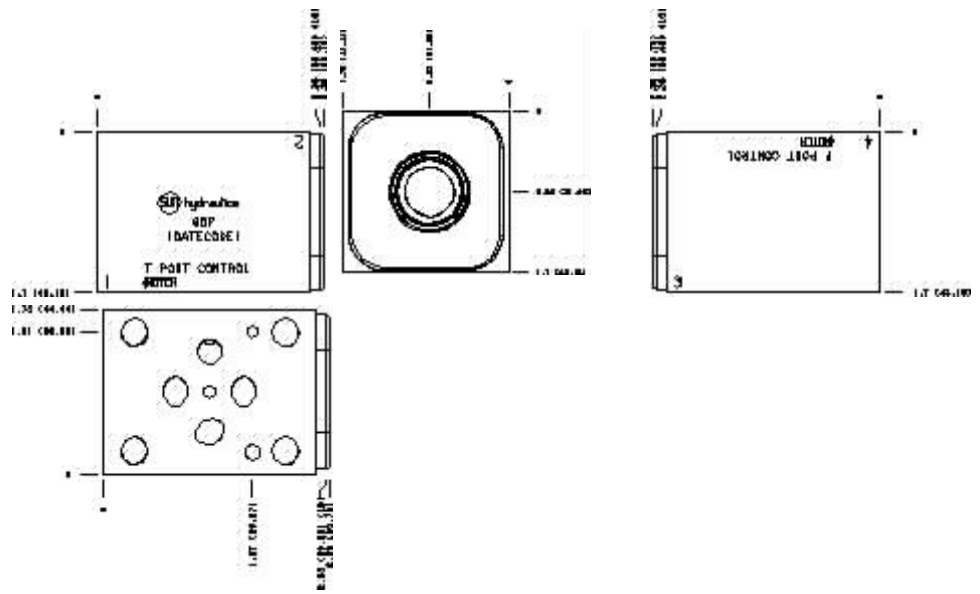

Copyright © 2007-2008 Sun Hydraulics Corporation.
All rights reserved.

[Terms and Conditions](#) - [Statement of Privacy](#)