

YUKEN**SOLENOID OPERATED
DIRECTIONAL VALVES*****-DSG-03-***-* -50/5090
3/8, Sub-plate Mounting****DIRECTIONAL
CONTROLS****Up to 31.5 MPa (4570 PSI), 120 L/min (31.7 U.S.GPM)****Mounting Surface : ISO 4401-AC-05-4-A, CETOP-5, NFPA-D02**

Terminal Box Type

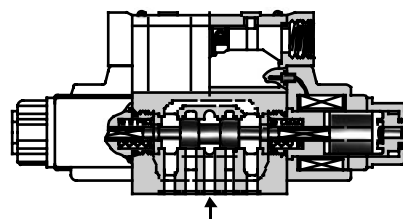

Plug-in Connector Type

**■ Features**

These are epoch-making solenoid operated directional valves of high pressure, high flow which have been developed incorporating a unique design concept into every part of the valve including the solenoid. With wet type solenoids, these valves ensure the low noise and the long life, moreover, ensure no leakage of oil outside of the valve.

● Wide Range of Models

Choose the optimum valve to meet your needs from a large selection available.

The DSG-03 50 design series solenoid operated directional valves are classified into the two basic models.

- Standard type.....Useable at high pressure: 31.5 MPa (4570 PSI) and high flow: 120 L/min. (31.7 U.S.GPM)
- Shockless type.....A noise at spool changeover and a vibration in piping can be reduced to a minimum.

● Stable Operation

With a strong magnet and spring force, the valves are tough against contamination and thus ensure a stable operation.

■ Solenoids**● Solenoid Connectors (DIN connector)**

The solenoid connectors conform to the international standard ISO 4400 (Fluid power systems and components-Three-pin electrical plug connectors-Characteristics and requirements).

● AC Solenoids

50 to 60 Hz common service solenoids do not require rewiring when the applied frequency is changed.

● DC Solenoids (Reputable K-series)

These DC solenoids have surge absorbers for K-series functions. The three advantages of them are as mentioned below:

1. Since surge voltage can be controlled to a very low figure, electric control devices, such as a computer, can be used without any interference like noise.
2. There being no spark between contacts, the life of the relay becomes longer.
3. Time lag for spool return after de-energisation of the solenoid is very short.

● R Type Solenoids

These are rectifier and surge absorber incorporated direct current solenoids which can be used by connecting directly to the AC power source. They have, like other DC solenoids, such advantages that the sound in on-off operation is quite low and the coils are hardly burnt out even if the spool is stuck at the half way of its changeover for contaminant particles etc. Moreover, they can be used almost permanently without being affected by a surge voltage from the outside. Thus, they are the solenoids of high reliability and durability.

● RQ Type Solenoids

These are solenoids having the same features as R type solenoids above plus such an additional feature that the time lag for the spool return after de-energisation of the solenoid becomes considerably shortened.

● Insulation Class of Solenoid Class H

The products approved by CSA (Canadian Standards Association) and the products conforming to the Low Voltage Directive 73/23/EEC (amended by 93/68/EEC) are also available. For the details, please consult us or your Yuken distributors.

■ Specifications

Valve Type	Model Numbers	Max. Flow [★] L/min (U.S.GPM)	Max. Operating Pressure MPa (PSI)	Max. T-Line Back Pres. MPa (PSI)	Max. Changeover Frequency min ⁻¹ (Cycles/Min)	Approx. Mass kg (lbs.)	
						Type of Solenoid	
						AC	DC, R, RQ
Standard Type	DSG-03-3C*-*-50/5090	120 (31.7)	31.5 (4570) [Spool Type 60 Only] 25 (3630)]	16 (2320)	240 (R Type Sol. Only) 120	3.6 (7.9)	5 (11)
	DSG-03-2D2*-*-50/5090					2.9 (6.4)	3.6 (7.9)
	DSG-03-2B*-*-50/5090					—	5 (11)
Shockless Type	S-DSG-03-3C*-*-50/5090	120 (31.7)	16 (2320)	16 (2320)	120	—	3.6 (7.9)
	S-DSG-03-2B2*-*-50/5090					—	3.6 (7.9)

★ The maximum flow means the limited flow without inducing any abnormality to the operation (changeover) of the valve. The maximum flow differs according to the spool type and operating conditions. For details, please refer to the "List of Standard Models and Maximum Flow" on pages 5 to 9.

■ Solenoid Ratings

Valve Type	Electric source	Coil Type	Frequency (Hz)	Voltage (V)		Current & Power at Rated Voltage			
				Source Rating	Serviceable Range	Inrush (A) ^{★2}	Holding (A)	Power (W)	
Standard Type	AC ^{★1}	A 100	50	100	80 - 110	5.37	0.90	—	
			60	100	90 - 120	4.57	0.63		
				110		5.03	0.77		
		A 120	50	120	96 - 132	4.48	0.75		
			60		108 - 144	3.81	0.52		
		A 200	50	200	160 - 220	2.69	0.45		
			60		200	180 - 240	2.29		0.31
					220		2.52		0.38
		A 240	50	240	192 - 264	2.24	0.37		
			60		216 - 288	1.91	0.26		
Shockless Type	DC (K Series)	D 12	—	12	10.8 - 13.2	—	3.16	38	
		D 24		24	21.6 - 26.4		1.57		
		D 100		100	90 - 110		0.38		
	AC→DC Rectified (R)	R 100	50/60	100	90 - 110	—	0.43	38	
		R 200		200	180 - 220		0.21		
	AC→DC Rectified (RQ) (Quick Return)	RQ100	50/60	100	90 - 110	—	0.43	38	

★1. AC solenoid is not available in shockless type.

R or RQ type models with built-in current rectifier is recommended for shockless operation with AC power.

★2. Inrush current in the above table show rms values at maximum stroke.

★3. There are more coil types other than the above. For details, please make inquiries.

The coil type numbers in the shaded column are handled as optional extras.
In case these coils are required to be chosen, please confirm the time of delivery with us before ordering.

■ Sub-plate

Piping Size	Japanese Standard "JIS"		European Design Standard		N.American Design Standard		Approx. Mass kg (lbs.)
	Sub-plate Model Numbers	Thread Size	Sub-plate Model Numbers	Thread Size	Sub-plate Model Numbers	Thread Size	
3/8	DSGM-03-40	Rc 3/8	DSGM-03-2180	3/8 BSP.F	DSGM-03-2190	3/8 NPT	3.0 (6.6)
1/2	DSGM-03X-40	Rc 1/2	DSGM-03X-2180	1/2 BSP.F	DSGM-03X-2190	1/2 NPT	3.0 (6.6)
3/4	DSGM-03Y-40	Rc 3/4	DSGM-03Y-2180	3/4 BSP.F	DSGM-03Y-2190	3/4 NPT	4.7 (10.4)

● Sub-plates are available. Specify the sub-plate model number from the table above.

When sub-plates are not used, the mounting surface should have a good machined finish.

■ Mounting Bolts

For socket head cap screws in the table below are included.

Descriptions	Soc. Hd. Cap Screw (4 pcs.)	Tightening Torque
Japanese Standard "JIS" European Design Standard	M6 × 35 Lg.	12 - 15 Nm (106 - 133 in. lbs.)
N. American Design Standard	1/4-20 UNC × 1-1/2 Lg.	

Model Number Designation

Model Number Designation													
F-	S-	DSG	-03	-2	B	2	A	-D24	-C	-*	-50	*	-L
Special Seals	Shockless Type	Series Number	Valve Size	Number of Valve Positions	Spool-Spring Arrangement	Spool Type	Special Two Position Valve (Omit if not required)	Coil Type	Manual Override	Electrical Conduit Connection	Design Number	Design Standard	Models with Reverse Mig. of Solenoid (Omit if not required)
F: For Phosphate Ester Type Fluids (Omit if not required)	None: Standard Type	DSG: Solenoid Operated Directional Valve	03	3: Three Positions	C: Spring Centred	2, 3 4, 40 5, 60 9, 10 11, 12	—	AC: A100 A120 A200 A240 DC: D12 D24 D100 R: (AC →DC) R100 R200 RQ: (AC →DC) RQ100	None: Manual Override Pin	None: Terminal Box Type	50	None: Japanese Std. "JIS" 90: N.American Design Std.	—
						2: Two Positions							
S: Shockless Type	—	3: Three Positions	C: Spring Centred	2 4	—	DC: D12 D24 D100 R: (AC →DC) R100 R200 RQ: (AC →DC) RQ100	—	C: Push Button and Lock Nut (Option)	N:^{*2} Plug-in Connector Type N1:^{*3} Plug-in Connector Type with Indicator Light (Option)	50	None: Japanese Std. "JIS" and European Design Std. 90: N. American Design Std.	—	
				2: Two Positions									A^{*1} B^{*1}

In the table above, the symbols or numbers highlighted with shade represent the optional extras. The valves with model number having such optional extras are handles as options, therefore, please confirm the time of delivery with us before ordering.

★ 1. In case of the special two position valve, please refer to page 10 for details.
 ★ 2. N is not available for RQ-type solenoids.
 ★ 3. N1 is not available for R and RQ-type solenoids.



Options

● Push Button with Lock Nut

Can be used for manual changeover of spool. The push button can be locked in the pressed condition.

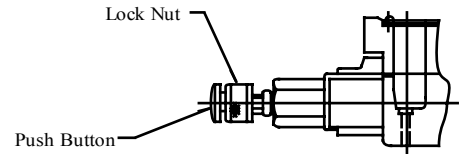

● Plug-in Connector with Solenoid Indicator Light

These are the indicator light incorporated plug-in connector type solenoids. Energisation or de-energisation of the solenoid can be easily identified with the incorporated indicator light.

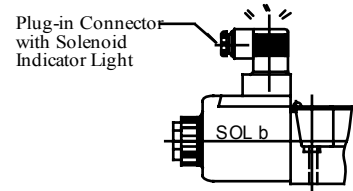

● M8 Mounting Bolts.

As the mounting bolts, M6 socket head cap screws are used for the standard valves, however, M8 socket head cap screws are also available for supply as optional extras. In case the M8 screws are required, suffix "02" to the design number of both valve and sub-plate model number like below.

(Example)

Valve: DSG-03-3C2-A100-5002

Sub-plate: DSGM-03-4002
The valve is supplied with 4 pcs. hexagon socket head cap screws M8 × 38 Lg.

Hydraulic Fluids

● Fluid Types

Any type of hydraulic fluid, listed in the table below can be used.

Petroleum base oils	Use fluids equivalent to ISO VG32 or VG46.
Synthetic fluids	Use phosphate ester or polyol ester fluid. When phosphate ester fluid is used, prefix "F-" to the model number because the special seals (fluororubber) are required to be used.
Water containing fluids	Use water-glycol fluids or W/O emulsion fluids.

Note: For use with hydraulic fluids other than those listed above, please consult your Yuken representatives in advance.

Recommended Viscosity and Oil Temperatures

Always be sure to use hydraulic fluids within the stipulated conditions shown below:

Viscosity: 15 to 400 mm²/s (77 to 1800 SSU), Temperature: -15 to +70°C (5 to 160°F)

Control of Contamination

Due caution must be paid to maintaining control over contamination of the hydraulic fluids which may otherwise lead to breakdowns and shorten the life of the valve. Please maintain the degree of contamination within NAS 1638-Grade 12. Use 25 μm or finer line filter.

Instructions

● Mounting Posture

In case No-spring detent type valves are used in the solenoid de-energised state, install the valve in such a way that the axis L-L' becomes horizontal to get the detent effect firmly. For the valve types other than the above, there are no restrictions on the mounting posture.

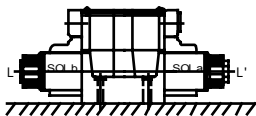

● Solenoid Energisation

For double solenoid valves do not energise both at the same time as it will result in coils burning out.

● Valve Tank Port

Avoid connecting the valve tank port to a line with possible surge pressure. Piping end of tank line should be submerged in oil.

● Shockless Type

In order to benefit from a shockless operation, it is necessary to fill the tank line with operating oil. Only after the tank line has been filled with operating oil, start the operation of the valve on a regular basis.

● Operating Force for Manual Override Push Pin

Please note that as the back pressure of the tank line rises, the manual override push pin turns hard to operate (see the graph below).

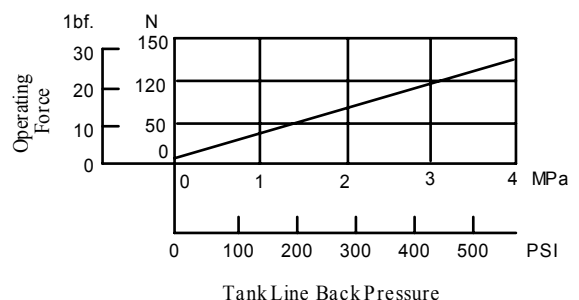

List of Standard Models and The Maximum Flow

Models with AC Solenoids: DSG-03-***-A*

No. of Valve Positions	Spool-Spring Arrangement	Model Numbers	Graphic Symbols	Max. Flow L/min											
				10 MPa	16 MPa	25 MPa	31.5 MPa	10 MPa	16 MPa	25 MPa	31.5 MPa	10 MPa	16 MPa	25 MPa	31.5 MPa
Three Positions	Spring Centred	DSG-03-3C2		100	100	100	100	100(70)	100(48)	96(28)	65(24)	100(70)	100(48)	96(28)	65(24)
		DSG-03-3C3		90	90	90	90	100(81)	100(81)	100(81)	100(81)	100(81)	100(81)	100(81)	100(81)
		DSG-03-3C4		80	80	80(65)	80(25)	100(58)	100(33)	76(22)	46(19)	100(58)	100(33)	76(22)	46(19)
		DSG-03-3C40		100	100	100	100	100(75)	100(62)	100(39)	84(21)	100(62)	100(39)	84(21)	48(18)
		DSG-03-3C5		30	30	30	30	26	21	18	16	30	28	28	28
		DSG-03-3C60		70	70	70	—	100	100	100	—	100	100	100	—
		DSG-03-3C9		100	100	100	100	60	60	60	60	60	60	60	60
		DSG-03-3C10		80	80	80(30)	80(20)	100(55)	100(36)	60(21)	34(16)	100(55)	100(36)	60(21)	34(16)
		DSG-03-3C11		100	100	100	100	100(80)	100(65)	85(35)	62(28)	100(80)	100(65)	85(35)	62(28)
		DSG-03-3C12		90	90	90(30)	90(20)	100(55)	100(36)	60(21)	34(16)	100(55)	100(36)	60(21)	34(16)
Two Positions	No-Spring Detented	DSG-03-2D2		100	100	100	100	40	40	30	28	60	60	40	35
	Spring Offset	DSG-03-2B2		100	100	100	100	34	24	20	19	100(62)	100(62)	100(44)	94(37)
		DSG-03-2B3		100	100	100	100	57	57	57	57	100(79)	100(72)	100(64)	100(59)
		DSG-03-2B8		—	—	—	—	26	19	18	16	100(35)	87(15)	61(9)	49(7)

Notes : 1. The relation between the maximum flow in the table above and the frequency/voltage (within the serviceable voltage) is as shown below.

(Example)

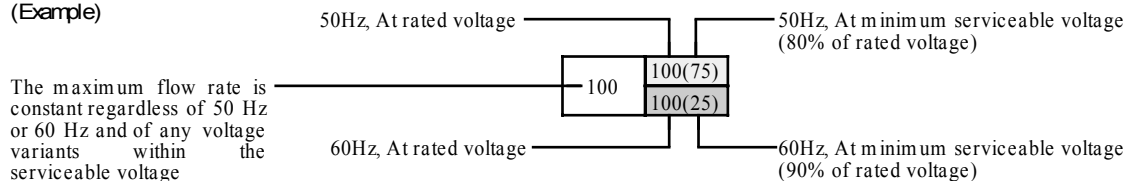











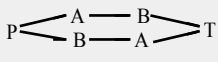

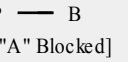

2. For the maximum flow rate in P → T of the valves with ★ mark, please see page 9.

The valve models with ★ mark are handled as Options. If you choose such valves, check the time of delivery beforehand.

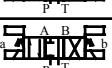
List of Standard Models

List of Standard Models and The Maximum Flow

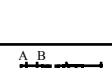
Models with AC Solenoids: DSG-03-***-A*

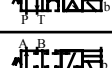
No. of Valve Positions	Spool-Spring Arrangement	Model Numbers	Graphic Symbols	Max. Flow U.S.GPM															
																			
				1450 PSI	2320 PSI	3630 PSI	4570 PSI	1450 PSI	2320 PSI	3630 PSI	4570 PSI	1450 PSI	2320 PSI	3630 PSI	4570 PSI				
Three Positions	Spring Centred	DSG-03-3C2		26.4	26.4	26.4	26.4	26.4 (18.5)	26.4 (12.7)	25.4 (7.4)	17.2 (6.3)	26.4 (18.5)	26.4 (12.7)	25.4 (7.4)	17.2 (6.3)				
		DSG-03-3C3 [◆]		23.8	23.8	23.8	23.8	23.8 (12.9)	14.0 (7.9)	9.0 (5.0)	6.7 (4.0)	23.8 (12.9)	14.0 (7.9)	9.0 (5.0)	6.7 (4.0)				
		DSG-03-3C4		21.1	21.1	21.1 (17.2)	21.1 (6.6)	26.4 (21.4)	26.4 (21.4)	4	4	26.4 (21.4)	26.4 (21.4)	4	4				
		DSG-03-3C40		26.4	26.4	26.4	7.9 (4.0)	26.4 (21.4)	26.4 (21.4)	4	4	26.4 (21.4)	26.4 (21.4)	4	4				
		DSG-03-3C5 [◆]		7.9	7.9	7.9	7.9	6.9	5.5	4.8	4.2	7.9	7.4	7.4	7.4				
		DSG-03-3C60 ⁺		18.5	18.5	18.5	—	26.4	26.4	26.4	—	26.4	26.4	26.4	—				
		DSG-03-3C9		26.4	26.4	26.4	26.4	15.9	15.9	15.9	15.9	15.9	15.9	15.9	15.9				
		DSG-03-3C10 [◆]		21.1	21.1	21.1 (7.9)	21.1 (5.3)	26.4 (14.5)	26.4 (9.5)	15.9 (5.5)	9.0 (4.2)	26.4 (14.5)	26.4 (9.5)	15.9 (5.5)	9.0 (4.2)				
		DSG-03-3C11 [◆]		26.4	26.4	26.4	26.4	26.4 (21.1)	26.4 (17.2)	22.5 (9.4)	16.4 (7.4)	26.4 (21.1)	26.4 (17.2)	22.5 (9.4)	16.4 (7.4)				
		DSG-03-3C12 [◆]		23.8	23.8	23.8 (7.9)	23.8 (5.3)	26.4 (14.5)	26.4 (9.5)	15.9 (5.5)	9.0 (4.2)	26.4 (14.5)	26.4 (9.5)	15.9 (5.5)	9.0 (4.2)				
Two Positions	No-Spring Detented	DSG-03-2D2		26.4	26.4	26.4	26.4	10.6	10.6	7.9	7.4	15.9	15.9	10.6	9.2				
	Spring Offset	DSG-03-2B2		26.4	26.4	26.4	26.4	26.4 (23.8)	26.4 (23.8)	26.4 (23.8)	26.4 (23.8)	9.0	6.3	5.3	5.0	26.4 (16.4)	26.4 (16.4)	26.4 (11.6)	24.8 (9.8)
		DSG-03-2B3		26.4	26.4	26.4	26.4	26.4 (19.8)	26.4 (19.8)	26.4 (19.8)	26.4 (19.8)	15.1	15.1	15.1	15.1	21.1 (11.1)	19.3 (9.5)	16.6 (9.0)	13.5 (8.7)
		DSG-03-2B8 [◆]		—	—	—	—	—	—	—	6.9	5.0	4.8	4.2	26.4 (20.9)	26.4 (19.8)	26.4 (16.4)	26.4 (15.6)	

Notes : 1. The relation between the maximum flow in the table above and the voltage (within the serviceable voltage) is as shown below.

(Example)

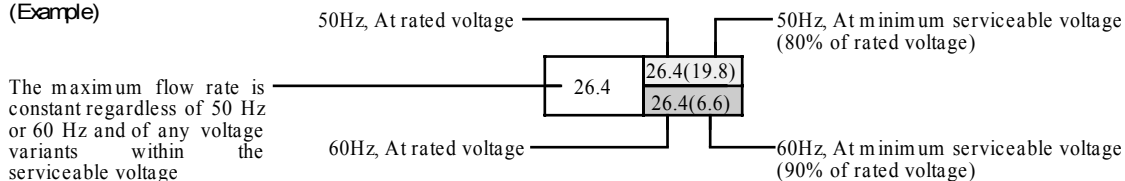







2. For the maximum flow rate in P → T of the valves with [◆] mark, please see page 9.

The valve models with [◆] mark are handled as Options. If you choose such valves, check the time of delivery beforehand.

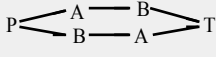
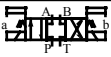
List of Standard Models

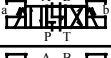
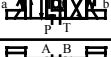
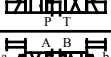
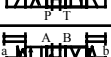
List of Standard Models and The Maximum Flow

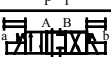
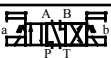
- Models with DC Solenoids: DSG-03-***-D*
- Models with R Type Solenoids: DSG-03-***-R*
- Models with RQ Type Solenoids: DSG-03-***-RQ 100*

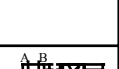
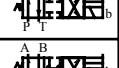
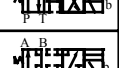
No. of Valve Positions	Spool-Spring Arrangement	Model Numbers	Graphic Symbols	Max. Flow L/min											
								P — A [Port "B" Blocked]				P — B [Port "A" Blocked]			
				10 MPa	16 MPa	25 MPa	31.5 MPa	10 MPa	16 MPa	25 MPa	31.5 MPa	10 MPa	16 MPa	25 MPa	31.5 MPa
Three Positions	Spring Centred	DSG-03-3C2		120	120	120	120	120	120	80	55	120	120	80	55
		DSG-03-3C3		120	120	120	120	120	120	120	120	120	120	120	120
		DSG-03-3C4		120	120	120	120	120	120	84	64	120	120	84	64
		DSG-03-3C40		120	120	120	120	120	120	62	49	120	120	62	49
		DSG-03-3C5		50	50	50	50	35	24	21	20	45	45	45	45
		DSG-03-3C60		120	120	120	—	120	120	120	—	120	120	120	—
		DSG-03-3C9		120	120	120	120	100	100	100	100	100	100	100	100
		DSG-03-3C10		120	120	120	65	120	112	60	51	120	112	60	51
		DSG-03-3C11		120	120	120	120	100	100	80	65	100	100	80	65
		DSG-03-3C12		120	120	120	65	120	120	62	51	120	120	62	51
Two Positions	No-Spring Detented	DSG-03-2D2		120	120	120	120	45	37	30	28	60	60	40	35
	Spring Offset	DSG-03-2B2		110	110	110	110	68	47	38	38	120	114	75	63
		DSG-03-2B3		120	120	120	120	77	77	77	77	120	120	120	120
		DSG-03-2B8		—	—	—	—	53	33	24	23	120	120	62	47

Notes) 1. The relation between the maximum flow in the table above and the voltage (within the serviceable voltage) is as shown below.

(Example)

The maximum flow rate is constant regardless of any voltage variants within the serviceable voltage

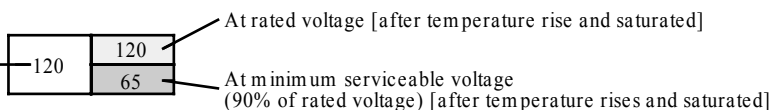

2. For the maximum flow rate in P → T of the valves with ★ mark, please see page 9.

The valve models with ★ mark are handled as Options. If you choose such valves, check the time of delivery beforehand.

List of Standard Models

List of Standard Models and The Maximum Flow

- Models with DC Solenoids: DSG-03-***-D*
- Models with R Type Solenoids: DSG-03-***-R*
- Models with RQ Type Solenoids: DSG-03-***-RQ 100*

No. of Valve Positions	Spool-Spring Arrangement	Model Numbers	Graphic Symbols	Max. Flow U.S. GPM												
				1450 PSI	2320 PSI	3630 PSI	4570 PSI	1450 PSI	2320 PSI	3630 PSI	4570 PSI	1450 PSI	2320 PSI	3630 PSI	4570 PSI	
Three Positions	Spring Centred	DSG-03-3C2		31.7	31.7	31.7	31.7	31.7	31.7	21.1	14.5	31.7	31.7	21.1	14.5	
		DSG-03-3C3		31.7	31.7	31.7	31.7	31.7	31.7	31.7	31.7	31.7	31.7	31.7	31.7	31.7
		DSG-03-3C4		31.7	31.7	31.7	31.7	31.7	31.7	22.2	16.9	31.7	31.7	22.2	16.9	
		DSG-03-3C40		31.7	31.7	31.7	31.7	31.7	31.7	16.4	12.9	31.7	31.7	16.4	12.9	
		DSG-03-3C5		13.2	13.2	13.2	13.2	9.2	6.3	5.5	5.3	11.9	11.9	11.9	11.9	
		DSG-03-3C60		31.7	31.7	31.7	—	31.7	31.7	—	—	31.7	31.7	31.7	—	
		DSG-03-3C9		31.7	31.7	31.7	31.7	26.4	26.4	26.4	26.4	26.4	26.4	26.4	26.4	26.4
		DSG-03-3C10		31.7	31.7	31.7	17.2	31.7	29.6	15.9	13.5	31.7	29.6	15.9	13.5	
		DSG-03-3C11		31.7	31.7	31.7	31.7	26.4	26.4	21.1	17.2	26.4	26.4	21.1	17.2	
		DSG-03-3C12		31.7	31.7	31.7	17.2	31.7	31.7	16.4	13.5	31.7	31.7	16.4	13.5	
Two Positions	No-Spring Detented	DSG-03-2D2		31.7	31.7	31.7	31.7	11.9	9.8	7.9	7.4	15.9	15.9	10.6	9.2	
	Spring Offset	DSG-03-2B2		29.1	29.1	29.1	29.1	18	12.4	10	10	31.7	30.1	19.8	16.6	
		DSG-03-2B3		31.7	31.7	31.7	31.7	20.3	20.3	20.3	20.3	31.7	31.7	31.7	27.2	
		DSG-03-2B8		—	—	—	—	14	8.7	6.3	6.1	31.7	31.7	16.4	12.4	

Notes) 1. The relation between the maximum flow in the table above and the voltage (within the serviceable voltage) is as shown below.

(Example)

The maximum flow rate is constant regardless of any voltage variants within the serviceable voltage

31.7	22.2
31.7	17.2

At rated voltage [after temperature rise and saturated]

At minimum serviceable voltage (90% of rated voltage) [after temperature rises and saturated]

2. For the maximum flow rate in P → T of the valves with ★ mark please see page 9.

The valve models with ★ mark are handled as Options. If you choose such valves, check the time of delivery beforehand.

■ Maximum Flow of Centre By-Pass

In valve type 3C3, 3C5 and 3C60, in case where the actuator is put on in between the cylinder ports A and B as illustrated below and where the actuator moves and suspended at its stroke end and where the valve is then shifted to the neutral position in the suspended state of the actuator, the maximum flow rates available are those as shown as the table below regardless of any voltage in the range of serviceable voltage.

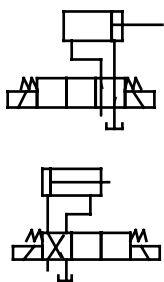

Model Numbers	Graphic Symbols	Max. Flow L/m in (U.S.GPM)			
		10 MPa (1450 PSI)	16 MPa (2320 PSI)	25 MPa (3630 PSI)	31.5 MPa (4570 PSI)
DSG-03-3C3-A*		100 (26.4)	100 (26.4)	100 (26.4)	100 (26.4)
DSG-03-3C3-D*/R*/RQ100		120 (31.7)	120 (31.7)	120 (31.7)	120 (31.7)
DSG-03-3C5-A*		26 (6.9)	21 (5.5)	18 (4.8)	16 (4.2)
DSG-03-3C5-D*/R*/RQ100		35 (9.2)	24 (6.3)	21 (5.5)	20 (5.3)
DSG-03-3C60-A*		84 (22.2)	52 (13.7)	52 (13.7)	—
DSG-03-3C60-D*/R*/RQ100		68 (18.0)	65 (17.2)	61 (16.1)	—

■ List of Shockless Models and The Maximum Flow

- Models with DC Solenoids: S-DSG-03-***-D*
- Models with R Type Solenoids: S-DSG-03-***-R*
- Models with RQ Type Solenoids: S-DSG-03-***-RQ 100

No. of Valve Positions	Spool-Spring Arrangement	Model Numbers	Graphic Symbols	Max. Flow L/m in (U.S.GPM)												
							P — A [Port "B" Blocked]			P — B [Port "A" Blocked]						
				5 MPa (730 PSI)	10 MPa (1450)	16 MPa (2320)	5 MPa (730 PSI)	10 MPa (1450)	16 MPa (2320)	5 MPa (730 PSI)	10 MPa (1450)	16 MPa (2320)				
Three Positions	Spring Centred	S-DSG-03-3C2		120 (31.7)	120 (31.7)	120 (31.7)	120 (31.7)	120 (31.7)	75 (19.8)	105 (27.7)	65 (17.2)	120 (31.7)	120 (31.7)	75 (19.8)	105 (27.7)	65 (17.2)
		S-DSG-03-3C4		120 (31.7)	120 (31.7)	85 (22.5) 70 (18.5)	120 (31.7)	120 (31.7)	75 (19.8)	105 (27.7)	65 (17.2)	120 (31.7)	120 (31.7)	75 (19.8)	105 (27.7)	65 (17.2)
Two Positions	Spring Offset	S-DSG-03-2B2		120 (31.7)	100 (26.4)	75 (19.8)	39 (10.3)	39 (10.3)	39 (10.3)	120 (31.7)	120 (31.7)	105 (27.7) 80 (21.1)				

Note: The relation between the maximum flow in the table above and the voltage (within the serviceable voltage) is as shown below.

(Example)

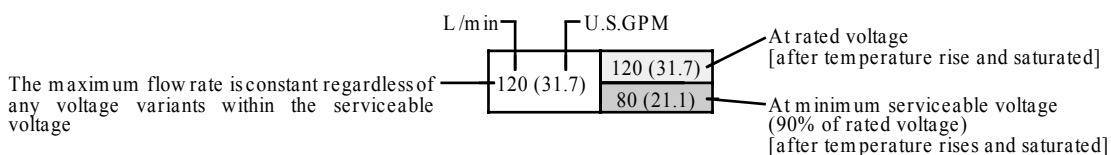

Reverse Mounting of Solenoid

Reverse Mounting of Solenoid

In spring offset type, it is a standard configuration that the solenoid is mounted onto the valve in the SOL b position (side). However, in this particular spool-spring arrangement, the mounting of the solenoid onto the valve in the reverse position -SOL a side- is also available. The graphic symbol for this reverse mounting is as shown below. As for the valve type 2B* A and 2B* B, please refer to the explanation under the heading of "Valves Using Neutral Position and Side Position" given below.

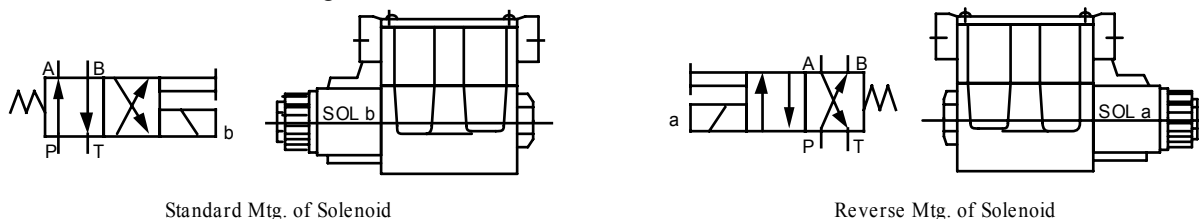

Valves Using Neutral Position and Side Position (Special Two Position Valve)

Besides the use of the standard 2-position valves aforementioned in the "List of Standard Models and Maximum Flow", the 3-position valves also can be used as the 2-position valves using the two of their three positions. In this case, there are two kinds of the valve available. One is the valve using the neutral position and SOL a position (2B* A) and another is the valve using the neutral position and SOL b position (2B* B).

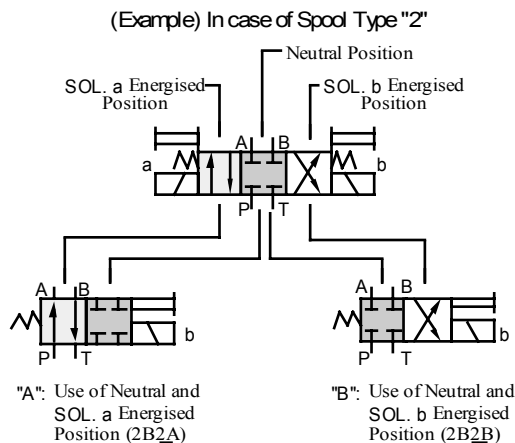

Model Numbers	Graphic Symbols	
	Standard Mtg. Type	Reverse Mtg. Type
(S-) DSG-03-2B* <u>A</u>		
(S-) DSG-03-2B2A		—

Model Numbers	Graphic Symbols	
	Standard Mtg. Type	Reverse Mtg. Type
DSG-03-2B <u>B</u>		
(S-) DSG-03-2B2B		
DSG-03-2B3B		—
(S-) DSG-03-2B4B		—
DSG-03-2B60B		—
DSG-03-2B10B		—

In the above table, the graphic symbols in mounting type highlighted with shade are optional extra, therefore, please confirm the time of delivery with us before ordering.

Typical Changeover Time

■ Typical Changeover Time

Changeover time varies according to oil viscosity, spool type and hydraulic circuit.

● Standard Type (Without Shockless Function)

[Test Conditions]

Pressure: 16 MPa (2320 PSI)

Flow Rate: 70 L/min (18.5 U.S.GPM)

Viscosity: 30 mm²/s (140 SSU)

Voltage: 100 %V (After coil temperature rises and saturated)

[Result of Measurement]

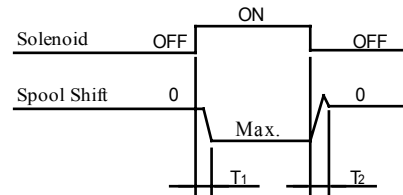

Type	Model Numbers	Changeover Time ms	
		T ₁	T ₂
Standard Type	DSG-03-3C2-A*	27	22
	DSG-03-3C2-D*	97	30
	DSG-03-3C2-R*	97	204
	DSG-03-3C2-RQ*	97	41

● Shockless Type

[Test Circuit and Conditions]

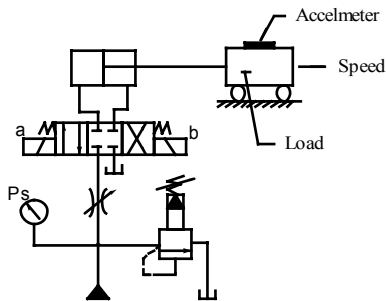

[Result of Measurement]

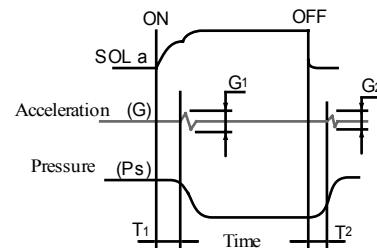

Setting Pressure (Ps): 7 MPa (1020 PSI)

Load (W): 1000 kg (2205 lbs.)

Speed: 8.8 m/min (28.9 ft/min)

Viscosity: 30 mm²/s (140 SSU)

Type	Model Numbers	Time ms		Acceleration m/s ² (G)	
		T ₁	T ₂	G ₁	G ₂
Shockless Type	S-DSG-03-3C2-D*	110	120	6.4 (.65)	6.4 (.65)
	S-DSG-03-3C2-R*	110	220		
	S-DSG-03-3C2-RQ*	110	120		

Pressure Drop

■ Pressure Drop

Pressure drop curves based on viscosity of 35 mm²/s (164 SSU) and specific gravity of 0.850.

● Standard Type: DSG-03

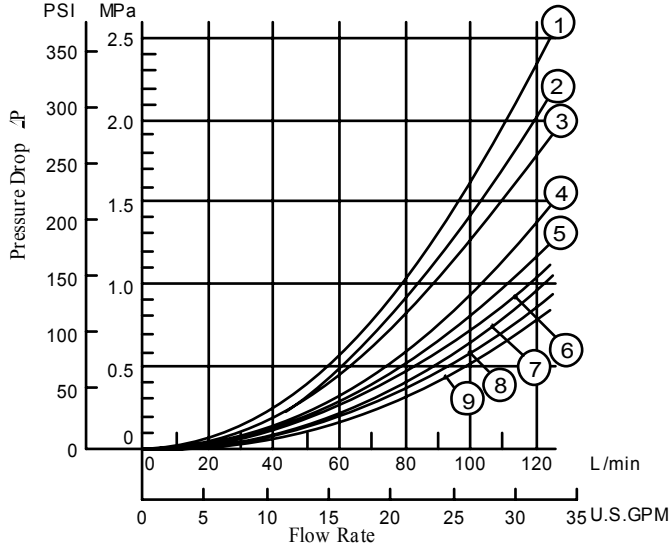

Model Numbers	Pressure Drop Curve Number				
	P→A	B→T	P→B	A→T	P→T
DSG-03-3C2	⑦	⑦	⑦	⑦	—
DSG-03-3C3	⑨	⑨	⑨	⑨	⑨
DSG-03-3C4	⑦	⑧	⑦	⑧	—
DSG-03-3C40	⑦	⑦	⑦	⑦	—
DSG-03-3C5	⑨	⑦	⑦	⑨	⑩
DSG-03-3C60	⑨	⑨	⑨	⑨	⑩
DSG-03-3C9	⑨	⑦	⑨	⑦	—
DSG-03-3C10	⑦	⑧	⑦	⑦	—
DSG-03-3C11	⑨	⑦	⑦	⑦	—
DSG-03-3C12	⑦	⑦	⑦	⑧	—
DSG-03-2D2	⑨	⑨	⑥	⑥	—
DSG-03-2B2	②	⑩	⑦	⑦	—
DSG-03-2B3	③	②	⑨	⑨	—
DSG-03-2B8	⑥	—	⑤	—	—

● Shockless Type: S-DSG-03

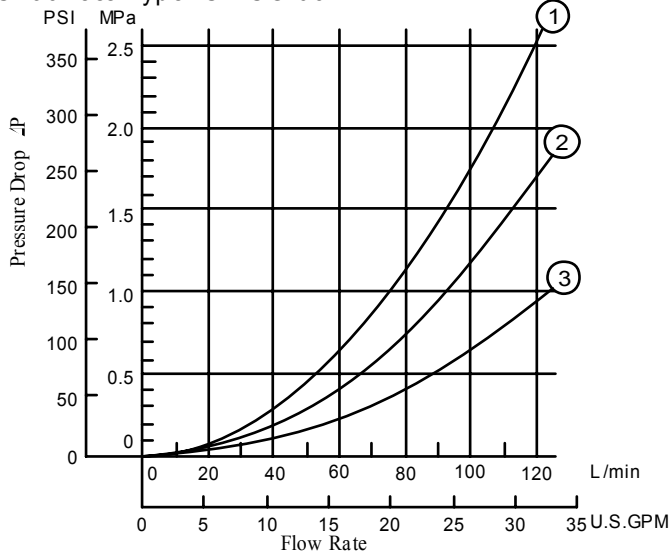

Model Numbers	Pressure Drop Curve Number			
	P→A	B→T	P→B	A→T
S-DSG-03-3C2	⑨	⑨	⑨	⑨
S-DSG-03-3C4	⑨	⑨	⑤	⑤
S-DSG-03-2B2	⑩	⑨	⑨	⑨

● For any other viscosity, multiply the factors in the table below.

Viscosity	mm ² /s	15	20	30	40	50	60	70	80	90	100
	SSU		77	98	141	186	232	278	324	371	417
Factor		0.81	0.87	0.96	1.03	1.09	1.14	1.19	1.23	1.27	1.30

● For any other specific gravity (G'), the pressure drop (P') may be obtained from the formula below.

$$\Delta P' = \Delta P (G'/0.850)$$

Mounting surface: ISO 4401-AC-05-4-A

TERMINAL BOX TYPE

■ Models with AC Solenoids: DSG-03-***-A*-50/5090

● Double Solenoid: Spring Centred & No-Spring Detented

Model Numbers	"C" Thd.
DSG-03-***-A*-50	G 1/2
DSG-03-***-A*-	1/2 NPT

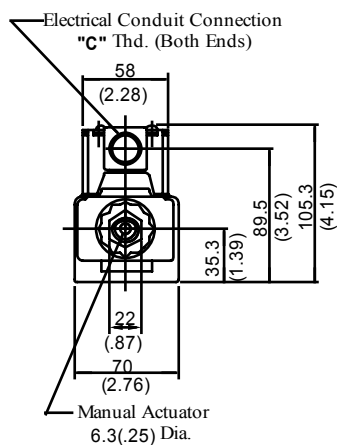
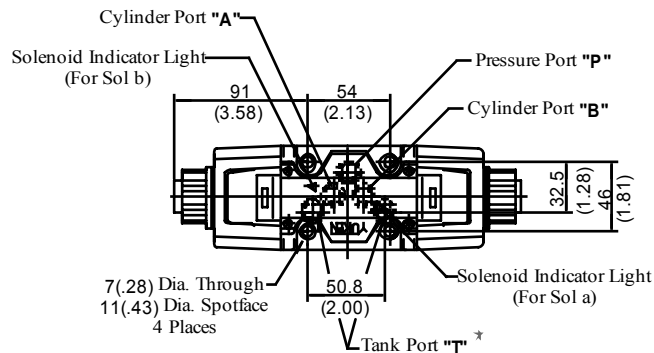

Space Needed to Remove Solenoid-Each End

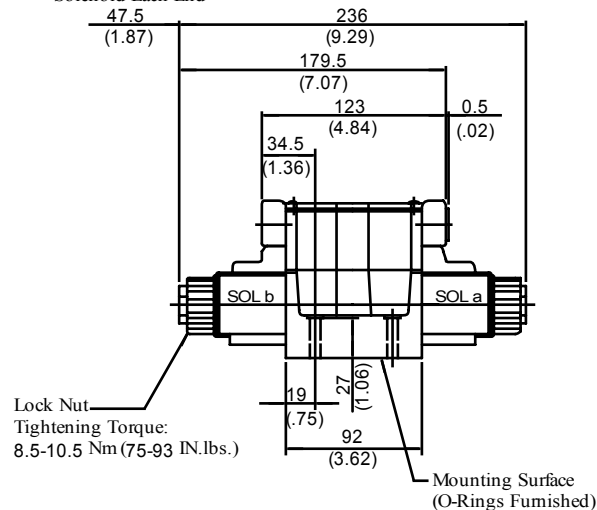

★. Of the two of tank port "T", the tankport in the left side is normally used in our standard sub-plate, though, either side of the tank port "T" can be used without problem.

DIMENSIONS IN MILLIMETRES (INCHES)

● Single Solenoid: Spring Offset

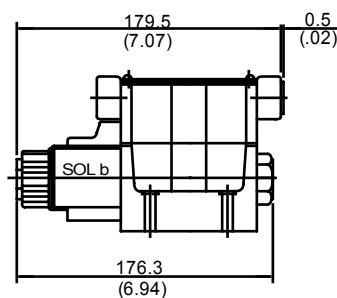

- For other dimensions, refer to "Spring Centred and No-Spring Detented" models.
- Solenoid being mounted in the reverse position -SOL a side- is also available.

TERMINAL BOX TYPE

- Models with DC Solenoids : (S-)DSG-03-***-D*-50/5090
- Models with R Type Solenoids : (S-)DSG-03-***-R*-50/5090
- Models with RQ Type Solenoids : (S-)DSG-03-***-RQ100-50/5090
- **Double Solenoid: Spring Centred & No-Spring Detented**
- **Single Solenoid: Spring Offset**

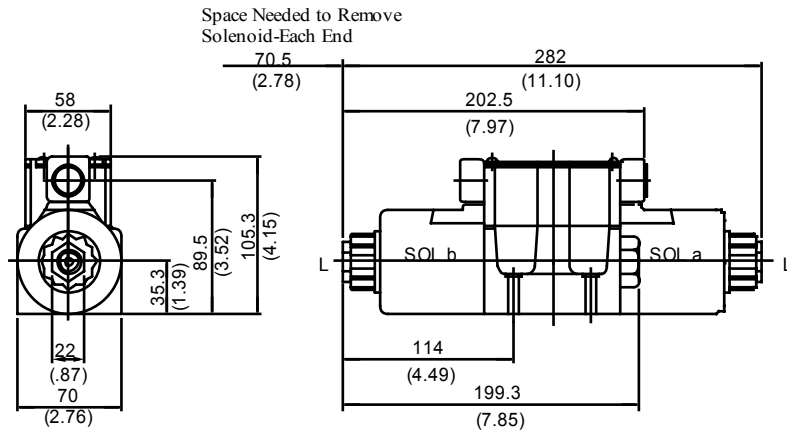

• For other dimensions, refer to Models with AC solenoids (Page 13).

DIMENSIONS IN
MILLIMETRES (INCHES)

Sub- plates

DSGM-03*-40/2180/2190

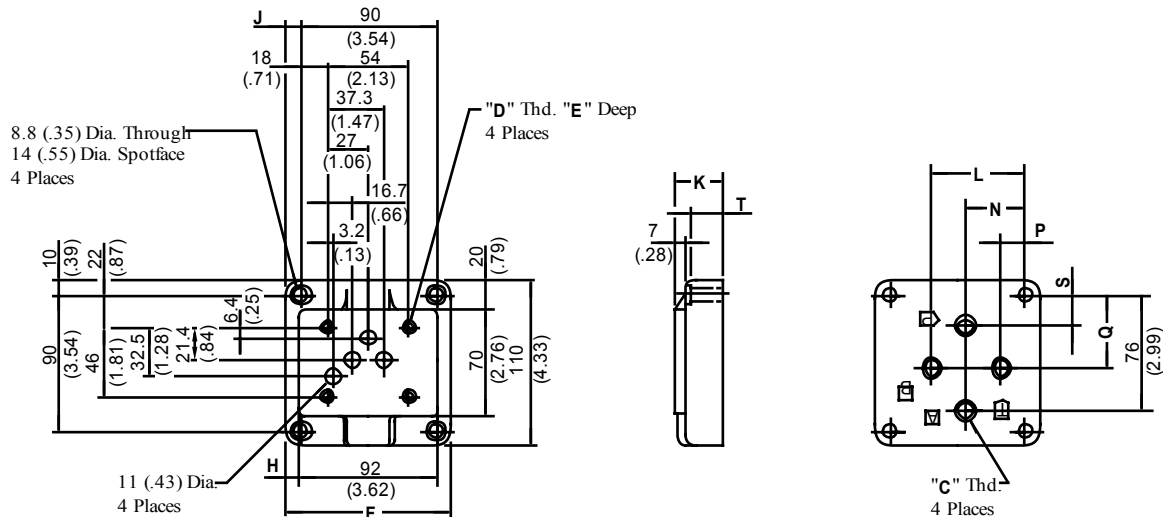

Sub-plate Model Numbers	Piping Size "C" Thd.	"D" Thd.	Dimensions mm (Inches)										
			E	F	H	J	K	L	N	P	Q	S	T
DSGM-03-40	Rc 3/8	M6	13 (.51)	110 (4.33)	9 (.35)	10 (.39)	32 (1.26)	62 (2.44)	40 (1.57)	16 (.63)	48 (1.89)	21 (.83)	24 (.94)
DSGM-03-2180	3/8 BSP.F		15 (.59)										
DSGM-03-2190	3/8 NPT	1/4-20 UNC	15 (.59)										
DSGM-03X-40	Rc 1/2	M6	13 (.51)	110 (4.33)	9 (.35)	10 (.39)	32 (1.26)	62 (2.44)	40 (1.57)	16 (.63)	48 (1.89)	21 (.83)	24 (.94)
DSGM-03X-2180	1/2 BSP.F		15 (.59)										
DSGM-03X-2190	1/2 NPT	1/4-20 UNC	15 (.59)										
DSGM-03Y-40	Rc 3/4	M6	13 (.51)	120 (4.72)	14 (.55)	15 (.59)	50 (1.97)	80 (3.15)	45 (1.77)	10 (.39)	47 (1.85)	16 (.63)	42 (1.65)
DSGM-03Y-2180	3/4 BSP.F		15 (.59)										
DSGM-03Y-2190	3/4 NPT	1/4-20 UNC	15 (.59)										

PLUG-IN CONNECTOR TYPE (N) PLUG-IN CONNECTOR WITH INDICATOR LIGHT (N1)

■ Models with AC Solenoids: DSG-03-***-A*^N/_{N1}-50/5090

The position of the Plug-in connector can be changed as illustrated below by loosening the lock nut. After completion of the change, be sure to tighten the lock nut with the torque as specified below.

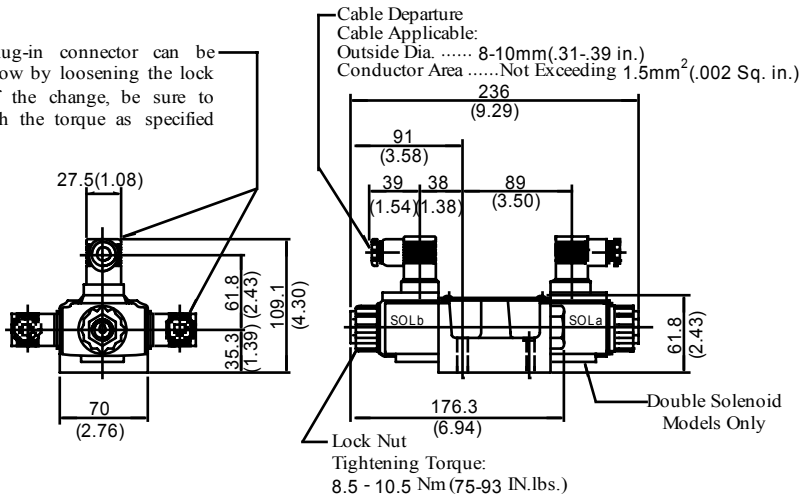

■ Models with DC Solenoids: (S-)DSG-03-***-D*^N/_{N1}-50/5090

■ Models with R Type Solenoids: (S-)DSG-03-***-R*^N-N-50/5090

The position of the Plug-in connector can be changed as illustrated below by loosening the lock nut. After completion of the change, be sure to tighten the lock nut with the torque as specified below.

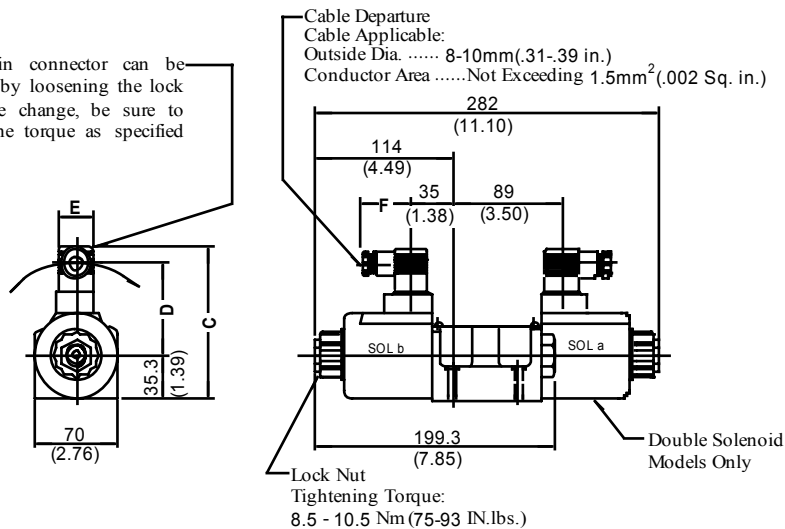

Model Numbers	Dimensions mm (Inches)			
	C	D	E	F
DSG-03-***-D* ^N / _{N1} -50/5090	121.1 (4.77)	73.8 (2.91)	27.5 (1.08)	39 (1.54)
DSG-03-***-R* ^N -N-50/	124.9 (4.92)	62.6 (2.46)	34 (1.34)	53 (2.09)

• For other dimensions, refer to "Terminal Box Type" (Page 13-14).

DIMENSIONS IN
MILLIMETRES (INCHES)

■ Options

Models with Push Button & Lock Nut: (S-)DSG-03-***-C*^N/_{N1}-50/5090

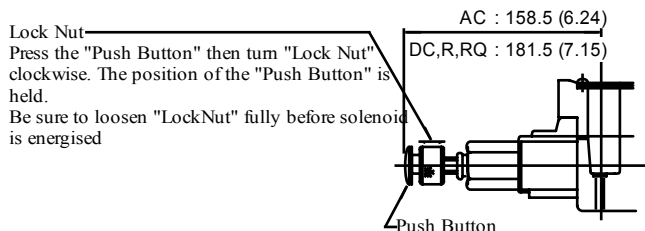

Details of Receptacle

Type of Electrical Conduit Connection	Double Solenoid Type	Single Solenoid Type
Terminal Box Type		
Plug-in Connector Type		

- ★ 1. There are two grounding terminals. You can use either one.
- ★ 2. If you do not need the common plate, remove it.
- ★ 3. With DC solenoids, polarity is no question.

DANGER

- Do not perform wiring while the power is on. Doing so may result in electric shock, burns or death.
- Make the wiring properly. Improper wiring will cause an irregular movement of the machine, resulting in a grave accident.

Electrical Circuit

Type of Electrical Conduit Connection	Electric Source		
	AC	DC	AC → DC Rectified
Terminal Box Type			
Plug-in Connector Type			

*-DSG-03-***-50/5090

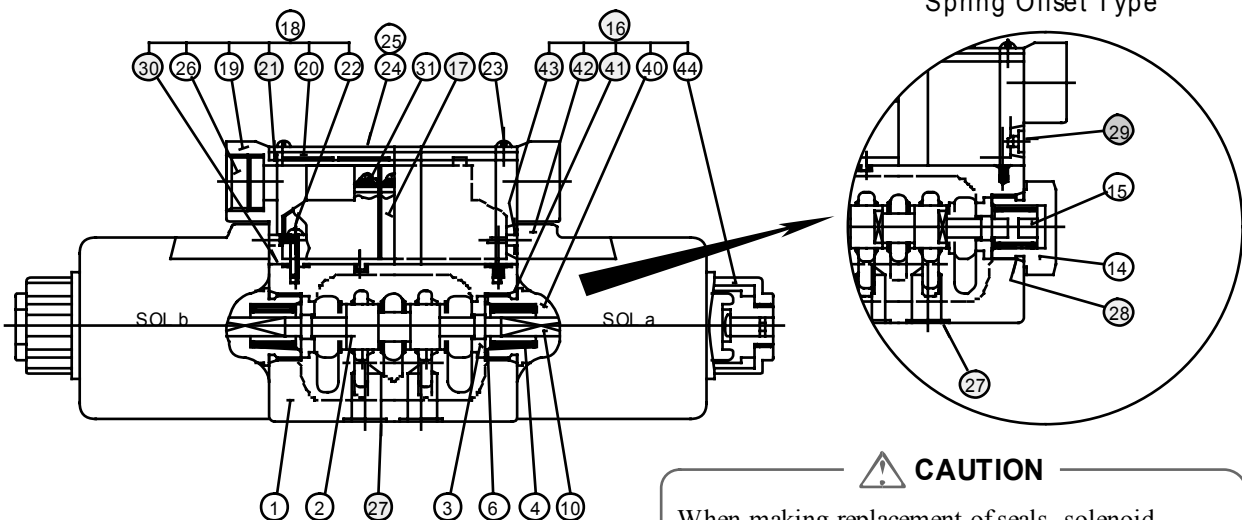

*-DSG-03-***-N/50/5090

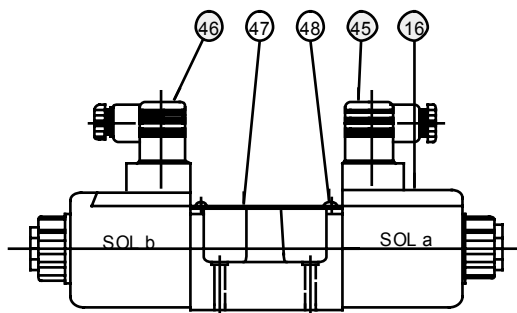

CAUTION

When making replacement of seals, solenoid assemblies or coils, please do it carefully after reading through the relevant instructions in the Operator's Manual.

WARNING

Before maintenance or removal, do the following. Failure to do these may cause components to move, causing oil leakage or start of the equipment's power supply, and be sure that serious accidents.

- Electric motors and engines have stopped.
- Return pressure in all hydraulic systems to zero.

● List of Seals

Item	Name of Parts	Part Numbers	Qty.			Remarks
			3C*	2D2	2B*	
21	Gasket	1751S-VK418689-6	1	1	1	
27	O-Ring	SO-NB-A014	5	5	5	
28	O-Ring	SO-NB-P21	—	—	1	
29	Plug	1790S-VK418329-2	—	—	2	
30	O-Ring	S6	2	2	2	
41	O-Ring	SO-NB-P21	2	2	1	} Included in Solenoid Ass'y (Item 16)
43	O-Ring	SO-NA-P4	4	4	2	

★ When ordering the O-Rings, please specify the seal kit number from the table below.

Valve Model Numbers	Seal Kit No.	O-Ring Details for Seal Kit
DSG-03-***-50/5090	KS-DSG-03-50	27 (5 Pcs.), 28 & 41 (2 Pcs., see above) 43 (4 Pcs.)
DSG-03-***-N/50/5090	KS-DSG-03-N-50	27 (5 Pcs.), 28 & 41 (2 Pcs., see above)

● Solenoid Ass'y, Coil, Receptacle and Connector

Refer to Page 18 for the details of these parts.

Spare Parts List

● Solenoid Ass'y, Coil, Receptacle and Connector Ass'y No.

Valve Model Numbers	⑩ Solenoid Ass'y No.	⑫ Coil No.	⑰ Receptacle Part No.	④⑤ Connector Ass'y Part No.	④⑥ Connector Ass'y Part No.	Remarks		
DSG-03-***-A100-50*	SA3-100-50	C-SA3-100-50	R3-60	—	—	Terminal Box Type		
DSG-03-***-A120-50*	SA3-120-50	C-SA3-120-50						
DSG-03-***-A200-50*	SA3-200-50	C-SA3-200-50						
DSG-03-***-A240-50*	SA3-240-50	C-SA3-240-50						
DSG-03-***-D12-50*	SD3-12-50	C-SD3-12-50	KR3-A-60					
DSG-03-***-D24-50*	SD3-24-50	C-SD3-24-50	KR3-C-60					
DSG-03-***-D100-50*	SD3-100-50	C-SD3-100-50	RR3-60					
DSG-03-***-R100-50*	SR3-100-50	C-SR3-100-50	QR3-C-60					
DSG-03-***-R200-50*	SR3-200-50	C-SR3-200-50	—					
DSG-03-***-RQ100-50*	SR3-100-50	C-SR3-100-50	—					
S-DSG-03-***-D12-50*	SD3-12-S-50	C-SD3-12-50	KR3-A-60	GDM-211-A-11	GDM-211-B-11	Plug-in Connector Type		
S-DSG-03-***-D24-50*	SD3-24-S-50	C-SD3-24-50						
S-DSG-03-***-D100-50*	SD3-100-S-50	C-SD3-100-50						
S-DSG-03-***-R100-50*	SR3-100-S-50	C-SR3-100-50						
S-DSG-03-***-R200-50*	SR3-200-S-50	C-SR3-200-50						
S-DSG-03-***-RQ100-50*	SR3-100-50	C-SR3-100-50						
DSG-03-***-A100-N-50*	SA3-100-N-50	C-SA3-100-N-50	—				GDME-211-R-A-10	GDME-211-R-B-10
DSG-03-***-A120-N-50*	SA3-120-N-50	C-SA3-120-N-50						
DSG-03-***-A200-N-50*	SA3-200-N-50	C-SA3-200-N-50						
DSG-03-***-A240-N-50*	SA3-240-N-50	C-SA3-240-N-50						
DSG-03-***-D12-N-50*	SD3-12-N-50	C-SD3-12-N-50						
DSG-03-***-D24-N-50*	SD3-24-N-50	C-SD3-24-N-50		GDM-211-A-11	GDM-211-B-11			
DSG-03-***-D100-N-50*	SD3-100-N-50	C-SD3-100-N-50						
DSG-03-***-R100-N-50*	SR3-100-N-50	C-SR3-100-N-50						
DSG-03-***-R200-N-50*	SR3-200-N-50	C-SR3-200-N-50						
S-DSG-03-***-D12-N-50*	SD3-12-S-N-50	C-SD3-12-N-50				GDME-211-R-A-10	GDME-211-R-B-10	
S-DSG-03-***-D24-N-50*	SD3-24-S-N-50	C-SD3-24-N-50						
S-DSG-03-***-D100-N-50*	SD3-100-S-N-50	C-SD3-100-N-50						
S-DSG-03-***-R100-N-50*	SR3-100-S-N-50	C-SR3-100-N-50						
S-DSG-03-***-R200-N-50*	SR3-200-S-N-50	C-SR3-200-N-50						
DSG-03-***-A100-N1-50*	SA3-100-N-50	C-SA3-100-N-50	—	GDML-211-1-11	GDML-211-1-11	Plug-in Connector with Indicator Light		
DSG-03-***-A120-N1-50*	SA3-120-N-50	C-SA3-120-N-50						
DSG-03-***-A200-N1-50*	SA3-200-N-50	C-SA3-200-N-50						
DSG-03-***-A240-N1-50*	SA3-240-N-50	C-SA3-240-N-50						
DSG-03-***-D12-N1-50*	SD3-12-N-50	C-SD3-12-N-50						
DSG-03-***-D24-N1-50*	SD3-24-N-50	C-SD3-24-N-50		GDML-211-2-11	GDML-211-2-11			
DSG-03-***-D100-N1-50*	SD3-100-N-50	C-SD3-100-N-50						
S-DSG-03-***-D12-N1-50*	SD3-12-S-N-50	C-SD3-12-N-50						
S-DSG-03-***-D24-N1-50*	SD3-24-S-N-50	C-SD3-24-N-50						
S-DSG-03-***-D100-N1-50	SD3-48-S-N-50	C-SD3-100-N-50					GDML-211-3-11	GDML-211-3-11
			GDML-211-1-11	GDML-211-1-11				

Note: The connector assembly is not included in the solenoid assembly.