

YUKEN

Pub: ALA-0402-70-2

DIRECTIONAL CONTROLS

SOLENOID OPERATED DIRECTIONAL CONTROL VALVES (F-)(S-)DSG-01-*-*-70 / 7090

Up to 5075 PSI (350 BAR), 26.4 GPM (100 l/min)

MOUNTING SURFACE: NFPA-D03, CETOP-3, NG6, ISO 4401-03-02-0-94

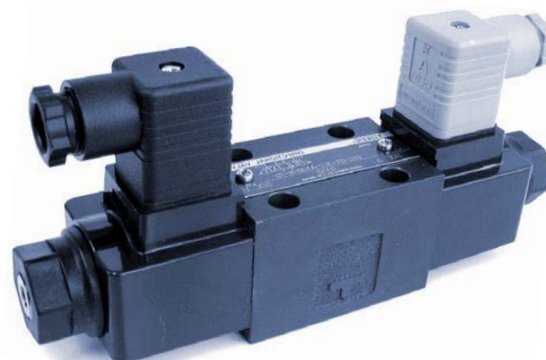
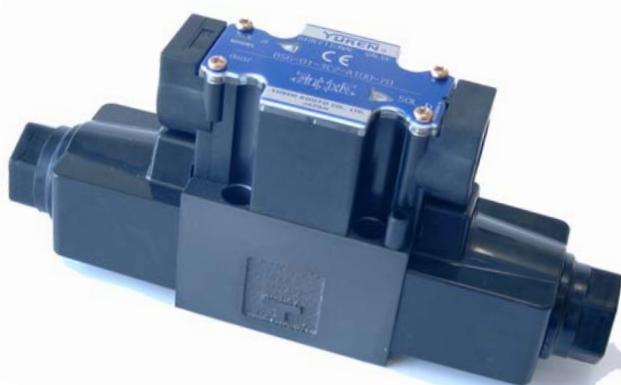

1/8" (CETOP3) Sub-Plate Mounting
(F-)(S-)DSG-01-*-*-70 / 7090

ALA INDUSTRIES LIMITED

Yuken Master Distributor
1150 Southpoint Drive, Suite D
Valparaiso, IN 46385
Toll Free: 877-419-8536
Tel: 219-465-4197
Fax: 219-477-4194

DESIGN APPROVALS:
UL, CE, & CSA



www.yuken-usa.com

SOLENOID OPERATED DIRECTIONAL VALVES - DSG-01 70 / 7090 SERIES



1/8" Sub-plate mounting. Mounting surface: ISO 4401-03-02-0-94, CETOP 3. NFPA-D01

■ FEATURE HIGHLIGHTS AND COMPARISON

	7090 Design	6090 Design (old)	
High Pressure	5075 PSI	4570 PSI	Port P, A, B
High Back Pressure	3045 PSI	2320 PSI	Port T
High Flow Rate	26.4 GPM	16.6 GPM	Both AC & DC
Low Pressure Drop	130 PSI	145 PSI	15.8 GPM, P to A
Power Consumption	29 W	29 W	DC Solenoid
Overall Length	8.05 inch	8.27 inch	DC Solenoid
Mass	4.1 lb	4.9 lb	Double Solenoid
Protection	IP65	IP64	
Approval	UL, CSA, CE	UL, CSA, CE	

AVAILABLE IN THE FOLLOWING TYPES

Standard Type	DSG-01
Low Energy Consumption	L-DSG-01
Soft Shift Type	S-DSG-01
Electrical Relay Inc. Type	T-DSG-01

■ FEATURES

These Solenoid Operated Directional Valves feature high pressure, high flow, high speed, low energy consumption and low pressure drop. These features are achieved using powerful, wet pin type solenoids and state-of-the-art flow channel designs.

- **Standard type:** Useable at high pressure: 5075 PSI and high flow: 26.4 U.S.GPM
- **Soft Shift type:** Noise at spool changeover and vibration in piping is reduced to a minimum.

Stable operation

With a strong magnet and spring force, the valves are tough against contamination and ensure a stable operation.

Solenoids

• AC Solenoids

50 to 60 Hz common service solenoids do not require rewiring when frequency is changed.

• DC Solenoids

These DC solenoids have incorporated surge absorbers. Advantages are:

- ⇒ Surge voltage can be controlled at a very low figure and electronic control devices, such as a computer, can be used without any noise interference.
- ⇒ Sparkless contacts extend the life of the relay.
- ⇒ Time lag for spool return after de-energization of the solenoid is very short.

• R Type Solenoids

These are rectifier and surge absorber incorporated direct

current solenoids which can be used by connecting directly to the AC power source. They have, like other DC solenoids, such advantages that the sound in on-off operation is quite low and the coils are rarely burnt out even if the spool is stuck at the half way point of its changeover. Moreover, they can be used almost permanently without being affected by a surge voltage from the outside. Thus, they are the solenoids of high reliability and durability.

- **Solenoid Insulation Class:** Class H

• Solenoid Connectors

⇒ (DIN connector)

The solenoid connectors conform to the international standard ISO 4400 (Three-pin electrical plug connectors). All valves with this option come standard with the DIN connectors included.

⇒ Terminal Box Connection

The terminal box connection incorporates the use of removable coils that connect to a terminal strip within the electrical conduit box via two sealed pins molded into the coils. This allows for easy removal of the coils without requiring re-wiring of the terminals. The terminal strip includes internal grounds that may be used to reduce wiring. All valves with the terminal box option come standard with indicator lights and dual 1/2" NPT ports to allow for conduit connections to the terminal box.

⇒ Lead Wire Connection

The lead wire connection uses a pair of 20 gauge wires per coil, each 15.7 inches in length.

SOLENOID OPERATED DIRECTIONAL VALVES - DSG-01 70 / 7090 SERIES

■ RATINGS

Valve Type	Model Numbers	Max. Flow (US GPM)	Max. Oper. Press. (PSI)	Max T-Line Back Press. (PSI)	Max Change Over Frequency Cyc./min.	Approx. Mass (Lb)	Protection IEC 529
Standard Type	(F)-DSG-01-3C*-*-7090	26.1*	5075	3045	300	4.1	IP65
	(F)-DSG-01-2D2*-*-7090					3.1	
	(F)-DSG-01-2B*-*-7090					4.1	
Soft Shift Type	(F)-S-DSG-01-3C*-*-7090	16.6*	3625		120	4.1	
	(F)-S-DSG-01-2B*-*-7090					3.1	

*The maximum flow depends on the type of spool and the operating condition. Refer to the list of spool functions Maximum Flow Rate tables for details.

■ SOLENOID RATINGS

Electrical Source	Coil Type	Freq. Hz	Voltage (V)		Current and Power		
			Source Rating	Serviceable Range	Inrush (A)	Holding (A)	Power (W)
AC	A100	50	100	80~110	2.42	0.51	-
			100	90~120	2.14	0.37	
		60	110		2.35	0.44	
	A120	60	120	96~132	2.02	0.42	
			108~144	1.78	0.31		
	A200	60	200	160~220	1.21	0.25	
			200	180~240	1.07	0.19	
		220	1.18		0.22		
	A240	60	240	192~264	1.01	0.21	
			216~288	0.89	0.15		
DC	-	-	12	10.8~13.2	-	2.45	29
			24	21.6~26.4		1.23	
			48	43.2~52.8		0.61	
			100	90~110		0.296	
			110	99~121		0.27	
			200	180~220		0.149	
			220	198~242		0.135	
AC to DC Rectified	50 / 60	-	100	90~110	-	0.33	29
			110	99~121		0.30	
			200	180~220		0.16	
			220	198~242		0.15	

■ Insulation class: H

■ ORIFICES

Orifices can be inserted in either P, A, B or T ports. However, in such cases, differential pressure at the orifice should be set less than 3050 PSI.

In cases where an orifice is inserted in the T-port, tank line pressure in the valve should be less than the specified maximum T-line back pressure.

In the event that differential pressure at the orifice exceeds 3050 PSI, consult Yuken for specific design valve which has threaded P, A, & B ports.

SOLENOID OPERATED DIRECTIONAL VALVES - DSG-01 70 / 7090 SERIES

MODEL NUMBER DESIGNATION

F-	-S	DSG	-01	-2	B	2	A	-D24	-C	-N	-P10	-70	90	-L	
Special Seals	Valve Type	Series Number	Valve Size	Number of Valve Positions	Spool Spring Arrangement	Spool Type (See page 5 & 7 for available spool types)	Special Two position valve (Omit if not required)	Coil Type	Manual Override	Electrical connection	Port Orifice ⁴	Design Number	Design Standard	Models with Reverse Mounting of Sol.	
F: For phosphate ester type fluids (omit if not required)	None: Standard Type S: Soft Shift Type	DSG: Solenoid operated dir. valve	01	3: Three position	C: Spring Centered	2, 3, 4, 40, 60, 9, 10, 11, 12	-	AC: A100 A120 A200 A240 DC D12 D24 D100 R: R100 R110	None: Manual Override Pin	None: Terminal Box Type None: 15.7 in. lead wire type (See design standard)	None: No Orifice	70	None: Japanese Standard 90: North American Standard 905: CSA Approval 912: 15.7 in. lead wire option	-	
				2: Two position	D: No Spring Detented B: Spring Offset	2	A ¹ B	C: Push Button & Lock Ass'y P: Push Pin with Rubber Dust Cover	N: Plug-in Connector Type (DIN) N1 ² : Plug-in Connector Type with Indicator Light BH: 3 or 5 pin Mini Plug-in Connector ³	A** B** Or P**	-	L			
	3: Three position	C: Spring Centered	2, 4, 40, 60	-	DC D12 D24 D100 R: R100 R110	-	-	-	-	-	-	-	-	L	
	2: Two position	B: Spring Offset	2	-	-	-	-	-	-	-	-	-	-	-	-

- 1 Special two position spools are available. Refer to "Valves with Center Position and one offset position" for details.
- 2 N1 is not available for R type solenoids
- 3 Mini Plug-in connector. 3-Pin for Single Solenoid, 5-Pin for Double Solenoid. See page 11 for details.
- 4 A for "A" Port, B for "B" Port & P for "P" Port Orifice. Indicate orifice size in millimeters.

SOLENOID OPERATED DIRECTIONAL VALVES - DSG-01 70 / 7090 SERIES

■ MAXIMUM FLOW RATES FOR STANDARD VALVES

Number of Valve Position	Spool-Spring Arrangement	Maximum Flow Rate U.S.GPM															
		P→A (B) →B (A) →T					P→A					P→B					
		Operating Pressure PSI					Operating Pressure PSI					Operating Pressure PSI					
		1450	2320	3625	4570	5075	1450	2320	3625	4570	5075	1450	2320	3625	4570	5075	
Three Positions	Spring Centred	3C2 	26.4	26.4	26.4	26.4	26.4	26.4(14.5)	11.9(9.2)	7.4(6.1)	6.6(5.0)	5.8(4.5)	26.4(14.5)	11.9(9.2)	7.4(6.1)	6.6(5.0)	5.8(4.5)
			26.4	26.4	26.4	26.4	26.4	26.4(11.4)	26.4(10.8)	21.1(5.5)	15.9(4.5)	10.0(4.0)	26.4(11.4)	26.4(10.8)	21.1(5.5)	15.9(4.5)	10.0(4.0)
		3C3 	26.4(21.1)	26.4(21.1)	26.4(21.1)	26.4(21.1)	26.4(21.1)	20.6(18.5)	20.6(18.5)	20.6(18.5)	20.6(18.5)	19.8(18.5)	20.6(18.5)	20.6(18.5)	20.6(18.5)	20.6(18.5)	19.8(18.5)
			26.4(21.1)	26.4(21.1)	26.4(21.1)	26.4(20.3)	26.4(20.3)	18.5(12.2)	18.5(12.2)	18.5(12.2)	18.5(12.2)	18.5(12.2)	18.5(12.2)	18.5(12.2)	18.5(12.2)	18.5(12.2)	18.5(12.2)
		3C4 	23.8	23.8	23.8(11.1)	13.2(6.9)	10.0(5.3)	26.4(16.4)	15.3(12.7)	10.0(7.9)	8.2(6.6)	7.7(6.1)	26.4(16.4)	15.3(12.7)	10.0(7.9)	8.2(6.6)	7.7(6.1)
			23.8	23.8	23.8	23.8(5.8)	9.2(4.8)	26.4(10.0)	20.1(7.4)	17.7(4.0)	15.1(2.6)	9.2(1.8)	26.4(10.0)	20.1(7.4)	17.7(4.0)	15.1(2.6)	9.2(1.8)
		3C40 	22.5	22.5	17.2(11.9)	10.6(7.9)	8.7(6.9)	22.5(17.2)	13.7(9.5)	7.9(6.6)	6.9(5.5)	6.3(5.0)	22.5(17.2)	13.7(9.5)	7.9(6.6)	6.9(5.5)	6.3(5.0)
			22.5	22.5	22.5	21.1(10.6)	21.1(5.8)	22.5(10.6)	22.5(9.2)	22.5(6.3)	15.9(4.2)	14.5(3.2)	22.5(10.6)	22.5(9.2)	22.5(6.3)	15.9(4.2)	14.5(3.2)
		3C60 	13.3(10.8)	13.3(10.8)	13.3(10.8)	13.3(10.8)	13.3(10.8)	17.4(15.3)	17.4(15.3)	17.4(15.3)	17.4(15.3)	17.4(15.3)	17.4(15.3)	17.4(15.3)	17.4(15.3)	17.4(15.3)	17.4(15.3)
			11.4(6.1)	11.4(6.1)	11.1(6.1)	11.1(6.1)	11.1(6.1)	14.2(8.4)	14.2(8.4)	13.7(8.4)	13.7(8.4)	13.7(8.4)	14.2(8.4)	14.2(8.4)	13.7(8.4)	13.7(8.4)	13.7(8.4)
Two Positions	Spring Offset	2D2 	26.4	26.4	26.4	26.4	26.4	5.3	4.0	2.6	2.6	2.1	5.3	4.0	2.6	2.6	2.1
			26.4	26.4	26.4	26.4	26.4	5.3	4.0	2.6	2.6	2.1	5.3	4.0	2.6	2.6	2.1
		2B2 	21.1	21.1	21.1	21.1	21.1	5.3	4.2	4.2	4.0	3.4	12.2(8.5)	8.2(6.1)	6.3(5.0)	5.8(4.8)	5.8(4.8)
			22.5	22.5	22.5	22.5	22.5	5.3	4.2	4.2	4.0	3.4	22.5(16.6)	21.1(13.2)	16.6(10.6)	11.6(8.5)	11.6(8.5)
		2B3 	18.5	18.5	18.5	18.5	18.5	13.2	13.2	13.2	13.2	13.2	19.8(17.2)	19.8(17.2)	19.8(17.2)	19.8(17.2)	19.8(17.2)
			18.5	18.5	18.5	18.5	18.5	13.2	13.2	13.2	13.2	13.2	21.1(18.5)	21.1(18.5)	21.1(18.5)	21.1(18.5)	21.1(18.5)
		2B8 	-	-	-	-	-	6.9	4.5	3.4	2.9	2.6	14.0(9.2)	9.2(7.9)	6.1(4.5)	5.0(3.4)	4.5(3.2)
			-	-	-	-	-	6.9	4.5	3.4	2.9	2.6	21.1(13.2)	18.5(10.6)	15.9(5.3)	11.9(2.6)	7.9(2.6)

Note 1. Maximum flow rate and applied current.

- Upper : DC,R
 - Middle : AC,50Hz
 - Lower : AC,60Hz
- () is added to the case where maximum flow rate differs to voltage.
The figure outside () is at rated voltage and inside () is at the minimum permissible solenoid voltage.

Example)

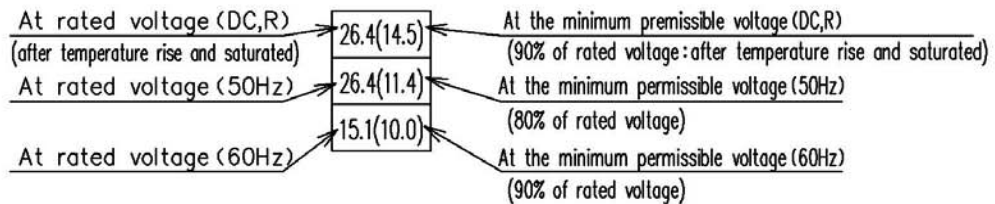

2. In spool type 60, P→T (Centre By-Pass) flow rates are limited as shown on the column at right side. Described maximum flow rates are regardless voltage within serviceable voltage range.

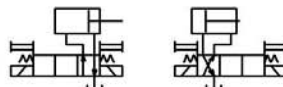



Spool Function	Max. Flow Rate U.S.GPM				
	Operating Pressure PSI				
	1450	2320	3625	4570	5075
3C60	14.6	11.7	7.9	6.9	5.8

SOLENOID OPERATED DIRECTIONAL VALVES - DSG-01 70 / 7090 SERIES

■ PRESSURE DROP

Pressure drop curves are based on viscosity of 164 SSU and specific gravity of 0.850

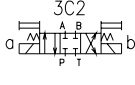
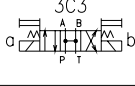
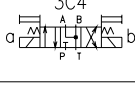
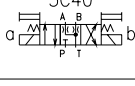
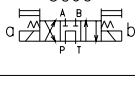
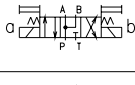
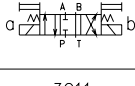
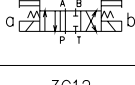
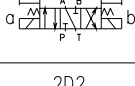
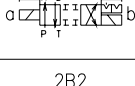
■ For Standard Valves models with AC, DC or R (Rectified solenoids)

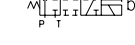
Number of Valve Position	Spool-Function Arrangement	Spool Functions Graphic Symbols	Pressure Drop Curve Number (Refer to pressure drop)					
			P→A	B→T	P→B	A→T	P→T	
Three Positions	Spring Centered		4	4	4	4	-	
			5	5	5	5	2	
			4	4	4	4	-	
			4	4	4	4	-	
			1	1	1	1	2	
			5	3	5	3	-	
			4	5	4	4	-	
			4	4	4	4	-	
			4	4	4	5	-	
		Two Positions	No-spring Detented		5	4	5	4
Spring Offset				5	4	5	4	-
				5	5	5	5	-
				5	-	4	-	-

□ Pressure Drop

Pressure drop curves based on viscosity of 164 SSU and specific gravity of .850.

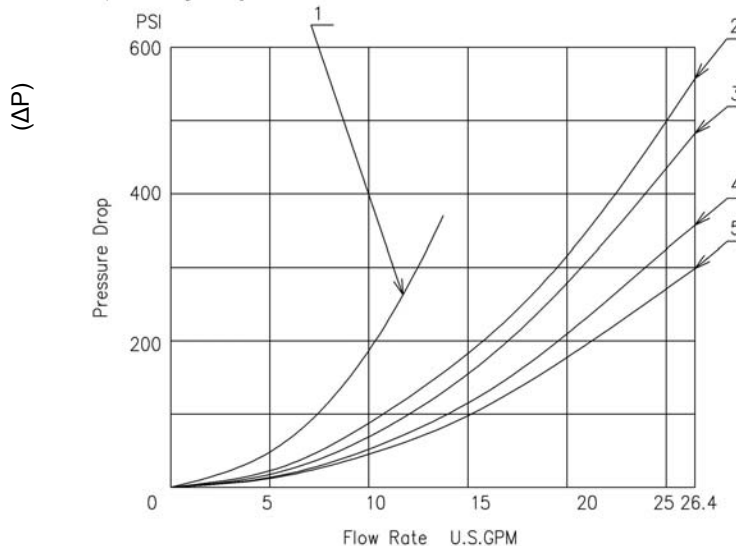

For corresponding spool types, see Maximum Flow Rate tables. For any other viscosity, multiply the factors in the table below

Viscosity (SSU)	77	98	141	186	232	278	324	371	417	464
Factor	0.81	0.87	0.96	1.03	1.09	1.14	1.19	1.23	1.27	1.30

For any other specific gravity, (G), the pressure drop (ΔP_1) may be obtained from the following formula: $\Delta P_1 = \Delta P \times (G/0.850)$

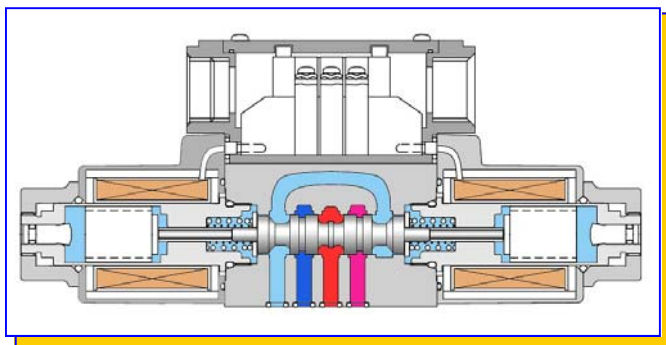

**1/8" (CETOP3) Sub-Plate Mounting
(F)-(S)-DSG-01-**-**-70 / 7090**

SOLENOID OPERATED DIRECTIONAL VALVES - DSG-01 70 / 7090 SERIES

■ MAXIMUM FLOW FOR SOFT SHIFT (S-) MODELS.

Number of Valve Position	Spool-Spring Arrangement	Maximum Flow U.S.GPM									Pressure Drop Curve Number (Refer to pressure drop)			
		P→A (B) →B (A) →T			P→A			P→B						
		Operating Pressure PSI			Operating Pressure PSI			Operating Pressure PSI			P→A	B→T	P→B	A→T
Three Positions	Spool-Function													
Spring Centered	Graphic Symbols													
Two Position	Spring Offset	1450	2320	3625	1450	2320	3625	1450	2320	3625				
	S-DSG-01-3C2	16.6	16.6	10.6	10.6 (8.5)	8.5 (5.3)	6.6 (4.2)	10.6 (8.5)	8.5 (5.3)	6.6 4.2	1	1	1	1
	S-DSG-01-3C4	15.9	13.2 (10.6)	10.6 (5.3)	10.6 (8.5)	8.5 (4.2)	4.2 (3.2)	10.6 (8.5)	8.5 (4.2)	4.2 (3.2)	1	2	1	2
	S-DSG-01-2B2	13.2 (11.9)	11.9 (10.6)	11.9 (10.6)	7.9	7.9	7.9	15.9	10.6	10.6	1	1	1	1

Note: The figure outside () is at rated voltage and inside () is at the minimum permissible solenoid voltage.

Example)

At rated voltage

(after temperature rise and saturated)

13.2
(11.9)

At the minimum permissible voltage

(90 % of rated voltage: after temperature rise and saturated)

■ PRESSURE DROP

Pressure drop curves are based on viscosity of 164 SSU and specific gravity of 0.850

■ For Soft Shift (S-) Valves Models with DC & R solenoids

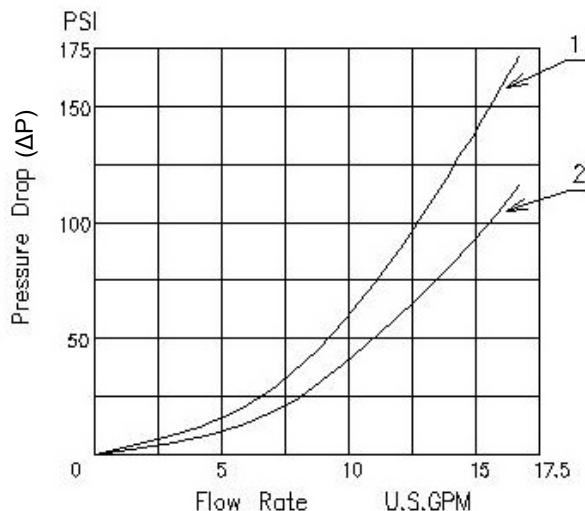

For any other specific gravity, (G), the pressure drop (ΔP_1) may be obtained from the following formula:
 $\Delta P_1 = \Delta P \times (G/0.850)$

For corresponding spool types, see Maximum Flow Rate tables above.
 For any other viscosity, multiply the factors in the table below

Viscosity	SSU	77	98	141	186	232	278	324	371	417	464
Factor		.81	.87	.96	1.03	1.09	1.14	1.19	1.23	1.27	1.30

YUKEN

SOLENOID OPERATED DIRECTIONAL VALVES - DSG-01 70 / 7090 SERIES

■ SPECIAL TWO-POSITION VALVE CONFIGURATION

■ Reverse Mounting of Solenoid.

In spring offset type, it is a standard configuration that the solenoid is mounted onto the valve in the SOL b position (side). However, in this particular spool-spring arrangement, the mounting of the solenoid onto the valve in the reverse position -SOL a side- is also available. The graphic symbol for this reverse mounting is as shown below. As for the valve type 2B*A and 2B*B, please refer to the explanation under the heading of "Valves Using Neutral Position and Side Position" given below.

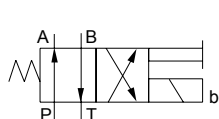

Standard Mtg. of Solenoid

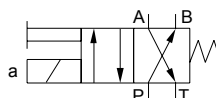
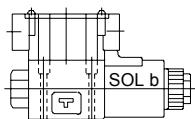

Reverse Mtg. of Solenoid

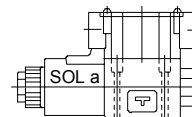

■ Valves Using Neutral Position and Side Position. (Special Two position Valve)

Besides the use of the standard 2-position valves aforementioned in the "List of Standard Models and Maximum Flow", the 3-position valves also can be used as the 2-position valves using the two of their three positions. In this case, there are two kinds of the valve available. One is the valve using the neutral position and SOL a position (2B*A) and another is the valve using the neutral position and SOL b position (2B*B).

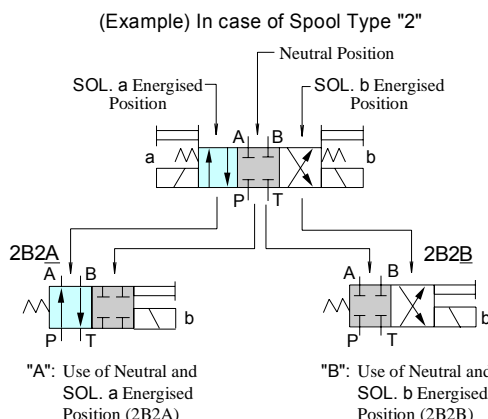

■ ALTERNATE TWO-POSITION SPOOL CONFIGURATIONS

Model Numbers	Graphic Symbols		Model Numbers	Graphic Symbols		Model Numbers	Graphic Symbols
	Standard Mtg. Type	Reverse Mtg. Type		Standard Mtg. Type	Reverse Mtg. Type		Standard Mtg. Type
DSG-01-2B*A			DSG-01-2B*B			DSG-01-2D*A	
DSG-01-2B2A			DSG-01-2B2B			DSG-01-2D2A	
DSG-01-2B3A			DSG-01-2B3B			Note : Optionals are marked with □.	
DSG-01-2B4A			DSG-01-2B4B				
DSG-01-2B40A			DSG-01-2B40B				
DSG-01-2B60A			DSG-01-2B60B				
DSG-01-2B8A			DSG-01-2B8B				
DSG-01-2B9A			DSG-01-2B9B				
DSG-01-2B10A			DSG-01-2B10B				
DSG-01-2B11A			DSG-01-2B11B				
DSG-01-2B12A			DSG-01-2B12B				

SOLENOID OPERATED DIRECTIONAL VALVES - DSG-01 70 / 7090 SERIES

<Models with AC Solenoids> Dimensions in Inches

Terminal Box Type
 Spring Centred
 No-Spring Detented

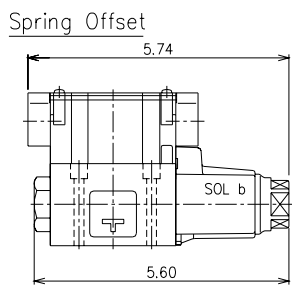
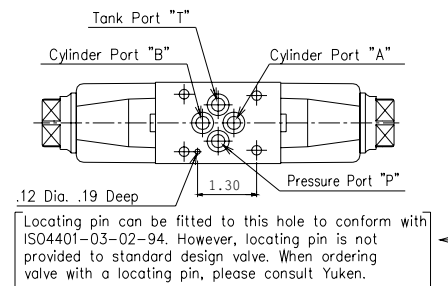
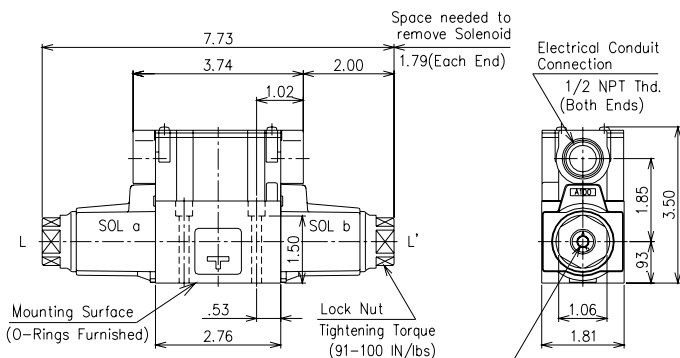
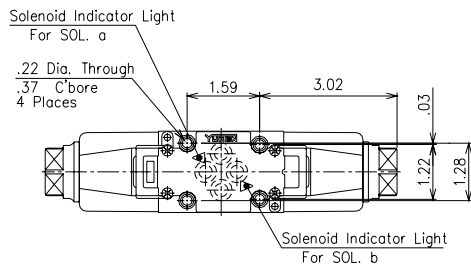

■ SUB-PLATE

Sub-plate model shown is bottom ported, NPT, cast iron. Other models are available as follows:

- Aluminum, Side ported, Multiple Station Manifolds, SAE (O-ring) ports

Contact your Yuken representative for details or request a Yuken sub-plate catalog.

Plug-in Connector type

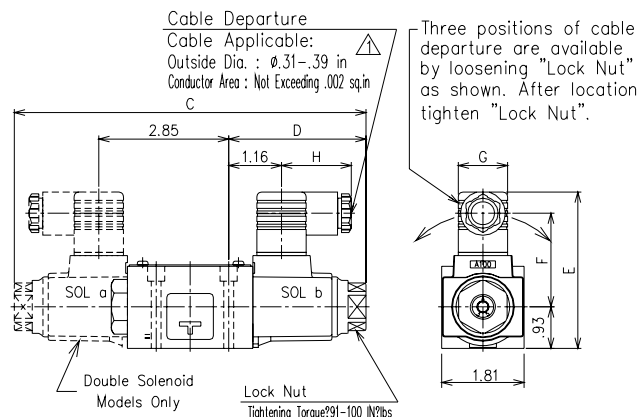

Model Numbers	C	D	E	F	G	H
(F-)DSG-01-****-A*-N*-7090	7.73	3.02	3.48	2.09	1.08	1.54
(F-)DSG-01-***-D*-N*-7090	8.05	3.18	3.92	2.52	1.08	1.54
(F-)DSG-01-****-R*-N*-7090	8.05	3.18	4.04	2.25	1.34	2.09

Manual Push Button & Lock Nut
 DSG-01-***-*-C*N**

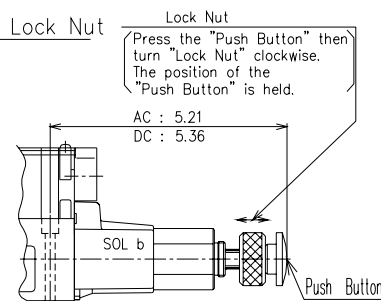

Be sure to loosen "Lock Nut" fully before solenoid is energized.

DSGM-01,01X,01Y Mounting Surface: ISO4401-AB-03-4-A
 No.10-24UNC Thd. .47 Deep
 4 Places
 1.26 .63
 ".D" Thd. 4 Places
 1.46 .94 .43 .49 1.40 2.30
 3.35 2.80 .28 .33 .20 1.02 1.22 1.25 1.89 2.48
 .28 Dia. 4 Places .50 .03 .61 .30
 .85 1.19 .56 .28 Dia. Through .43 Dia. Spotface 2 Places

Sub-Plate Model Numbers	D	Approx. Mass lbs
DSGM-01 -3190	1/8 NPT	1.8
DSGM-01X-3190	1/4 NPT	
DSGM-01Y-3190	3/8 NPT	

Sub-plates are available. Specify sub-plate model from the table above. When sub-plates are not used, the mounting surface should have a good machined finish.

Mounting Bolts
 Socket head Cap Screws (No.10-24UNC X 1-3/4Lg. ,4pcs.) and O-Rings (AS568-012 NBR,Hs90, 4pcs.) are included.

SOLENOID OPERATED DIRECTIONAL VALVES - DSG-01 70 / 7090 SERIES

<Models with DC or R Solenoids>

□ Terminal Box Type
Spring Centred

Dimensions in Inches

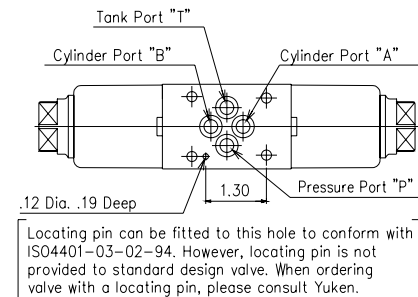
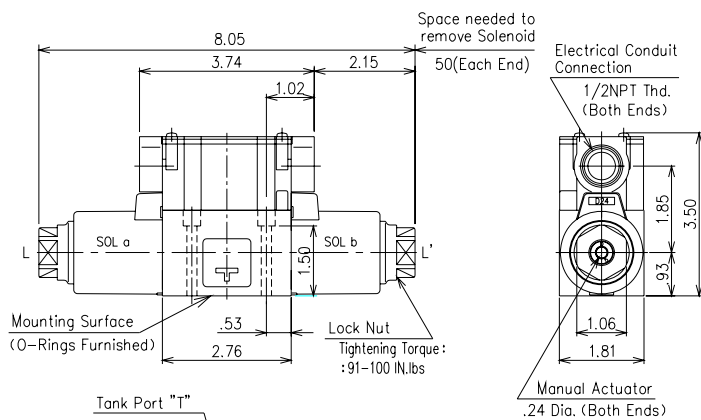
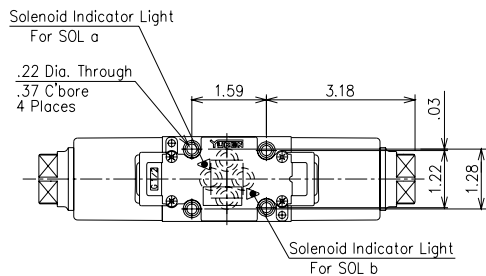

Spring Offset

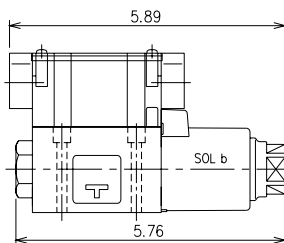

□ Plug-in Connector type

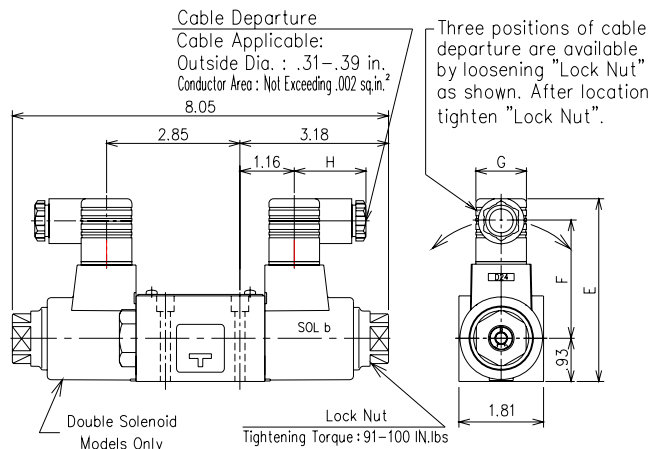

Model Numbers	E	F	G	H
(F-) S-DSG-01-***-D*-N*	3.92	2.52	1.08	1.54
(F-) S-DSG-01-***-R*-N	4.04	2.25	1.34	2.09

Manual Push Button & Lock Nut
(F-) S-DSG-01-***-*-C

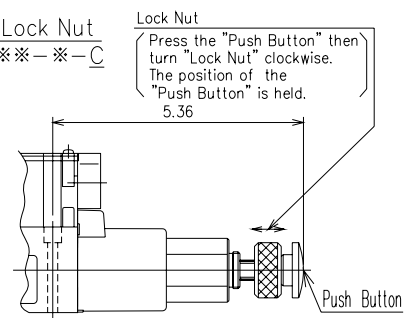

Be sure to loosen "Lock Nut" fully before solenoid is energised.

- High Pressure
- High Flow Rate
- High Back Pressure
- Low Pressure Drop
- Tight Protection
- UL,CSA,CE Approval
- Compact Size & Light Weight

SOLENOID OPERATED DIRECTIONAL VALVES - DSG-01 70 / 7090 SERIES

INSTRUCTIONS

MOUNTING

No-spring detented models not energized continuously must be installed so that the spool axis (See "L" to "L" in dimensional information) will be horizontal. Other models are not restricted to mounting horizontally.

ENERGIZATION

On double solenoid valves, do not energize both solenoids at the same time. Solenoid burn-out may occur.

VALVE TANK PORT

Avoid connection of the valve tank port to a line where surge pressure is likely to occur. Pipe end of tank line should be submerged in oil.

TIGHTENING TORQUE OF MOUNTING BOLTS.

44 - 62 in/lbs (53 - 62 in/lbs applicable for working pressures more than 3025 PSI.)

OPERATING FORCE BY MANUAL ACTUATOR

Take care as the operating force by the manual actuator increases in proportion to the tank line back pressure. (See graph below)

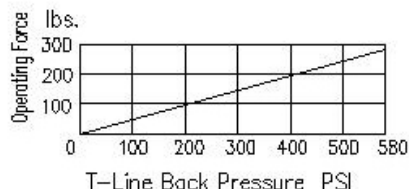

HYDRAULIC FLUID

Type of Fluid

- Petroleum based fluids: Equivalent to ISO VG32 or 46.
- Synthetic fluids: Phosphate ester or Polyol ester type
- Water Containing Fluids: Water-glycol fluids or W/O emulsion type.

Recommended Viscosity and Temperature

- Always be sure to use hydraulic fluids within the stipulated conditions as follows:
 Viscosity: 77 to 1800 SSU
 Oil Temperature: 5 to 160 degrees F

Control of Contamination

- Due caution must be used to maintain control over contamination of hydraulic fluids which may otherwise lead to breakdown and shorter valve life.
- Please maintain the degrees of contamination between NAS 1638-Grade 12, Use 9.8 x 10 inch or filter line filter

SOFT SHIFT TYPE

In order to benefit from the shockless operation, it is necessary to fill the tank line with operating oil. Start operation of the valve on a regular basis only after the tank line has been filled.

TYPICAL CHANGEOVER TIME

Type	Model Number	Time (s)	
		T1	T2
Standard AC	(F-)DSG-01-***-A*-7090	0.01-0.02	0.02-0.04
Standard DC	(F-)DSG-01-***-D*-7090	0.03-0.045	0.02-0.03
Standard Rectified	(F-)DSG-01-***-R*-7090	0.04-0.05	0.10-0.20
Soft Shift DC	(F-)S-DSG-01-***-D*-7090	0.10-0.20	0.05-0.10
Soft Shift Rectified	(F-)S-DSG-01-***-R*-7090	0.10-0.20	0.15-0.20

[Test Conditions]

Pressure: 2320 PSI
 Flow Rate: 8.3 U.S. GPM
 Viscosity: 164 SSU
 Voltage: 100%V
 (After coil temperature rises and saturated.)

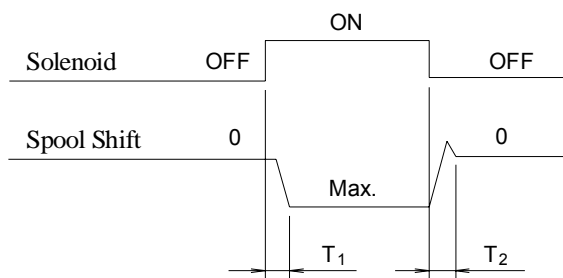

INTERFACE: MINI PLUG-IN CONNECTOR

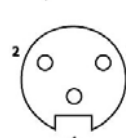
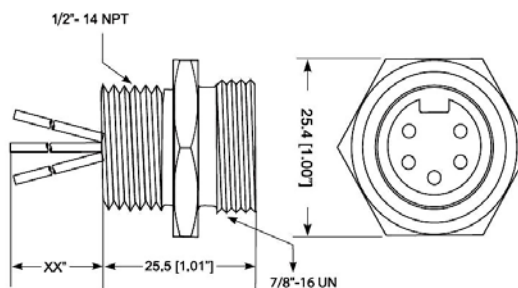
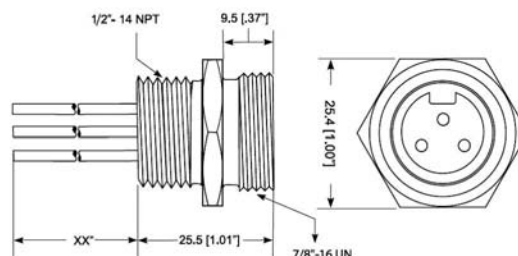

- 1 = Green (Ground)
- 2 = Red/White (Positive)
- 3 = Red/Black (Negative)

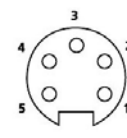

- 1 = "B" Sol. Red/White (Positive)
- 2 = "A" Sol. Red (Common)
- 3 = Green (Ground)
- 4 = "A" Sol. Red/Yellow (Positive)
- 5 = "B" Sol. Red/Black (Common)

SOLENOID OPERATED DIRECTIONAL VALVES - DSG-01 70 / 7090 SERIES

LEAD WIRE CONNECTION AND DETAILS OF RECEPTACLE

Type of Electrical Conduit Connection	Double Solenoid Type	Single Solenoid Type
Terminal Box Type		
Plug-in Connector Type		

- ★ 1. There are two grounding terminals. You can use either one.
- ★ 2. If you do not need the common plate, remove it.
- ★ 3. With DC solenoids, polarity is no question.

⚠ DANGER

- Do not perform wiring while the power is on. Doing so may result in electric shock, burns or death.
- Make the wiring properly. Improper wiring will cause an irregular movement of the machine, resulting in a grave accident.

ELECTRICAL CIRCUIT

Type of Electrical Conduit Connection	Electric Source		
	AC	DC	AC→DC Rectified
Terminal Box Type			
Plug-in Connector Type			