

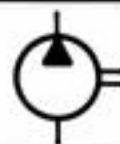

# HYDRAULIC PUMPS

## GEAR PUMPS 40 Series Specification Sheet



The CROSS Series 40 gear pumps feature a gear tooth design that provides more displacement within a given package size. Available in 6 sizes, with displacements from .50 to 1.80 cubic inches per revolution, this compact pump can deliver up to 17.5 gpm in a space less than 5" x 5 1/4" x 5 1/4". Gear tooth design and pressure-balanced loading plates provide high volumetric and overall efficiency while operating at a low noise level.

### GENERAL SPECIFICATIONS

Displacement Sizes:	0.50	0.75	1.00	1.25	1.50	1.80	cu.in./Rev.
	8.2	12.3	16.4	20.5	24.6	29.5	cc/Rev.

Rated working pressure (max. relief valve setting at full flow) . . . . . 3000 psi (207 Bar)  
 Maximum shock and surge pressure . . . . . 3500 psi (242 Bar)  
 Maximum flow rate (delivery) . . . . . 17.5 gpm (66 l/m)  
 Maximum speed (continuous - see Inlet Vacuum Curves) . . . . . 3600 RPM  
 Maximum horsepower (at rated speed and pressure) . . . . . 41 hp (30.5 kw)  
 Mounting (any position) . . . . . SAE "A" size, 2-Bolt  
 Weight . . . . . Approx. 7 lbs. (3.2 kg)

### MATERIAL SPECIFICATIONS

Body and end covers . . . . . Die cast aluminum alloy  
 Gears . . . . . Sintered metal  
 Shafts . . . . . Hardened steel  
 Seals . . . . . Buna N  
 Bearings . . . . . Pressure lubricated, Teflon impregnated sleeve

### STANDARD FEATURES

- Rotation: Right hand (clockwise)
- O-ring ports: 1" SAE #16 (1 5/16 - 12) inlet, 3/4" SAE #12 (1 1/16 - 12) outlet
- Shaft: 5/8" diameter, Woodruff keyed • Shaft Seal: 20 psi (1.4 bar)\*

### OPTIONAL FEATURES AVAILABLE

- Rotation: Left hand (counterclockwise); Bi-directional (Dual Rotation)
- Ports: SAE #12 (3/4") O-ring inlet (1 1/16 - 12); rear inlet and outlet location
- Shafts: 5/8" Dia. SAE splined (9 tooth, 16/32 pitch, 30° P.A. flat root side fit Class I); 5/8" Dia. with Woodruff key (long); 3/4" Dia. with Woodruff key (short); 3/4" Dia. with Woodruff key (long)
- Shaft Seal: High pressure, 250 psi (17.2 bar)\*

NOTE: Refer to CROSS pump and motor technical service sheet for side and end load limitations, oil recommendations, start-up procedures, etc.

\* Dual rotation pumps are provided with 250 psi shaft seals.



**DIMENSIONAL DATA** in inches and (millimeters)

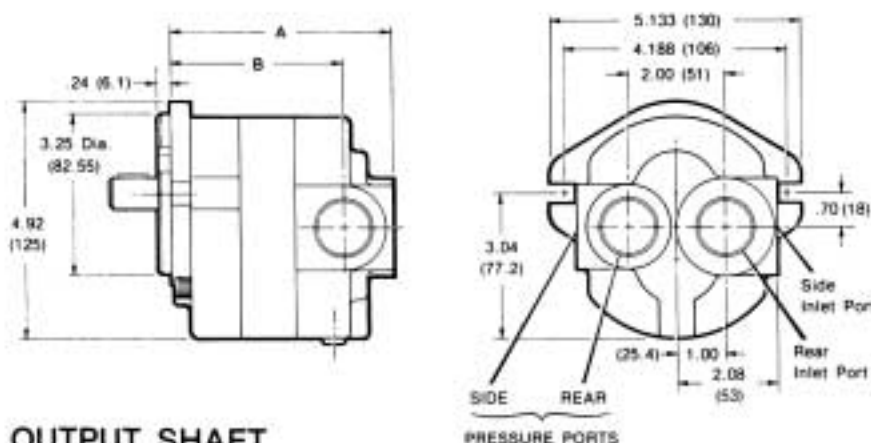

Displacement cu.in./Rev. (cc/Rev.)	Dim. "A" inches (mm)	Dim. "B" inches (mm)
.50 (8.2)	4.25 (108)	3.23 (82)
.75 (12.3)	4.44 (113)	3.42 (87)
1.00 (16.4)	4.62 (117)	3.60 (91)
1.25 (20.5)	4.81 (112)	3.79 (96)
1.50 (24.6)	4.99 (127)	3.97 (101)
1.80 (29.5)	5.22 (133)	4.20 (107)

**OUTPUT SHAFT**

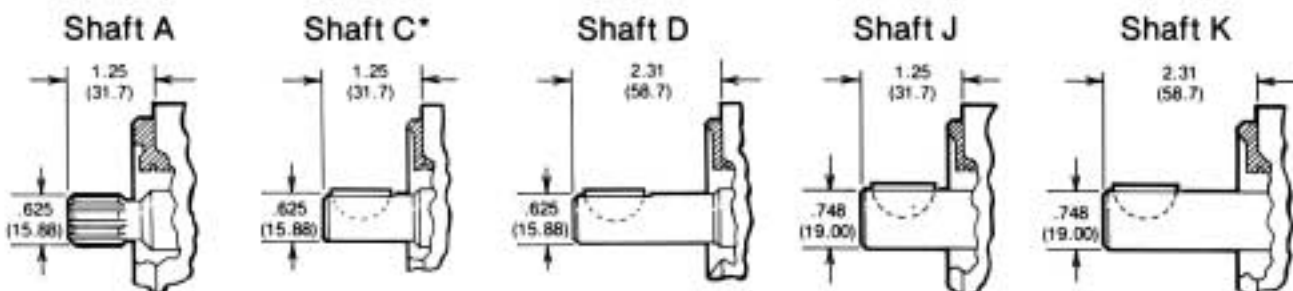

Shaft "A": 9 Tooth, 16/32 pitch, 30° pressure angle, flat root side fit, Class I.  
 Shaft "C" and "D": Woodruff key - 3/4" dia. x 5/32.  
 Shaft "J" and "K": Woodruff key - 3/4" dia. x 5/32.

**ORDERING DATA**

Series	Type	Special Options	Size cu.in./R x 10	Rotation	Mounting	Shaft Size & Type	Ports Location and Size						
							Inlet	Outlet					
40	P pump	O 20 psi Pump Seal H 250 psi Shaft Seal (Standard for dual rotation)	5	D Dual	A SAE "A" 2-Bolt	A 5/8" spline	SA	1 5/16	1 1/16	Side			
			7										
			10										
			12										
			15										
			18								L Left	D 5/8" Dia. Keyed	SC
R Right	D 5/8" Dia. Keyed (long)	RB	1 5/16	1 1/16									
					J* 3/4" Dia. Keyed	RD	1 1/16	1 1/16					
									K 3/4" Dia. Keyed (Long)				

\* Not available in 40 P007 model.

EXAMPLE: 40P05RACSA is a standard Series 40 pump with a 20 psi shaft seal, 0.50 cu.in./Rev. displacement, right rotation, SAE "A" 2-bolt mounting, 3/4" dia. keyed shaft and side ports with 1 5/16" inlet and 1 1/16" outlet.



# HYDRAULIC PUMPS

## GEAR PUMPS 40 Series

### TYPICAL PERFORMANCE DATA

#### MODEL 40P005

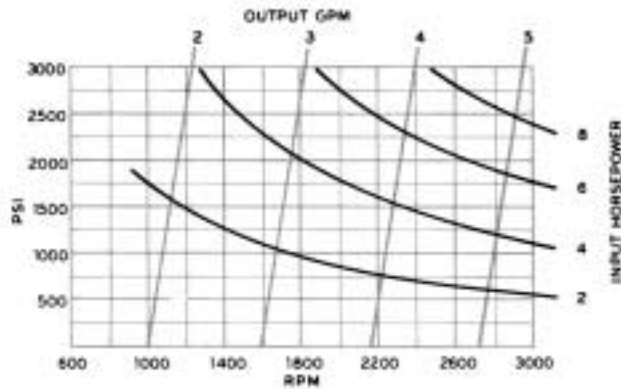

#### MODEL 40P012

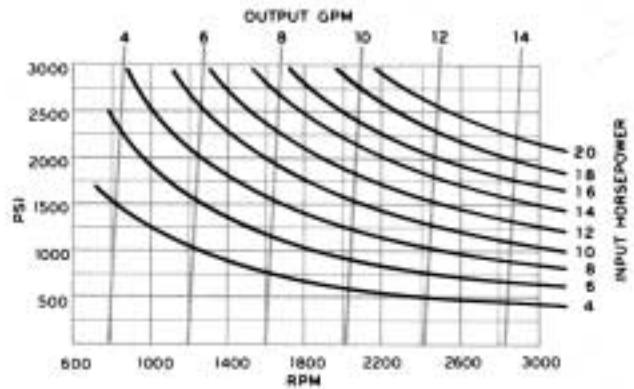

#### MODEL 40P007

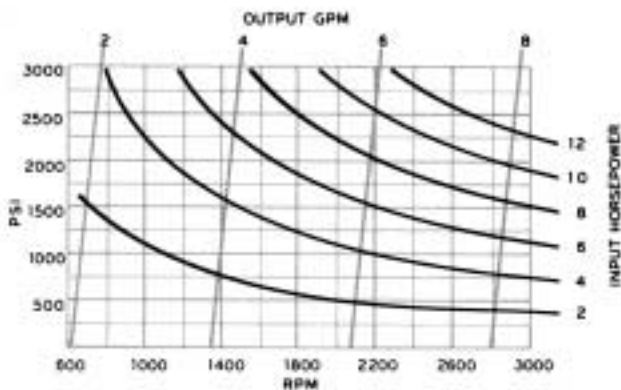

#### MODEL 40P015

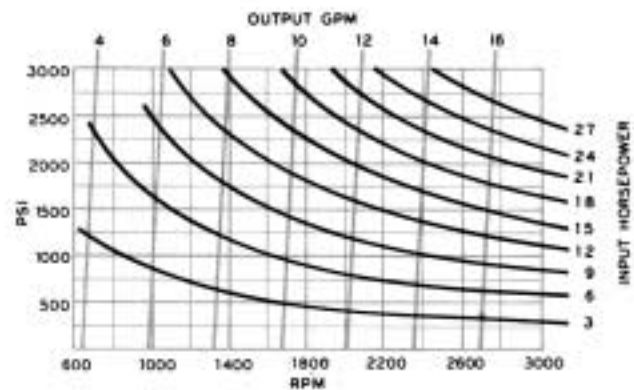

#### MODEL 40P010

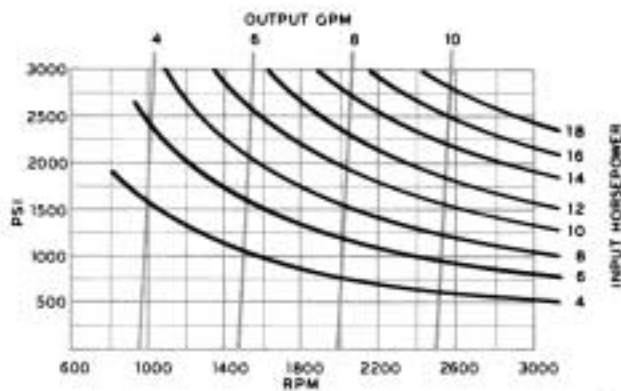

#### MODEL 40P018

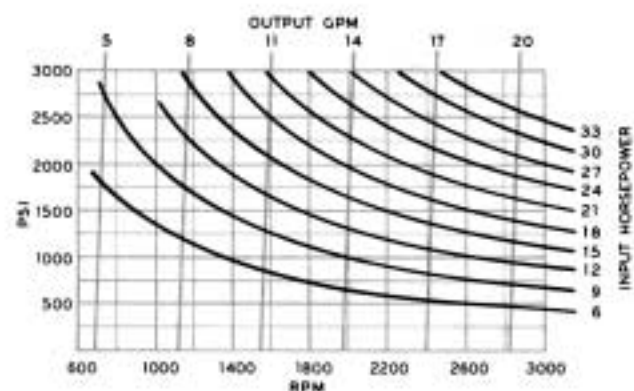



**TYPICAL PERFORMANCE DATA**

**MODEL 40P005**

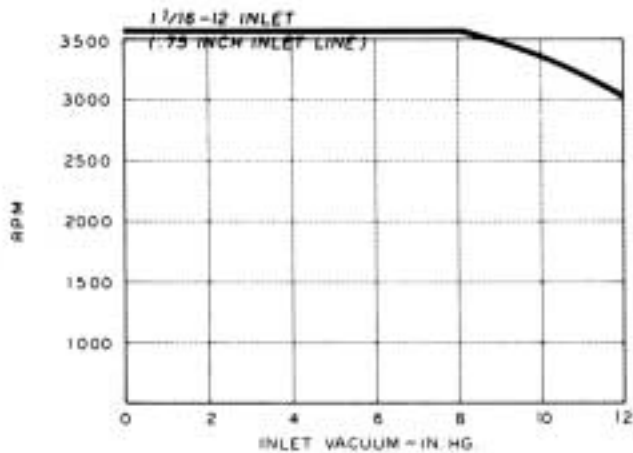

**MODEL 40P012**

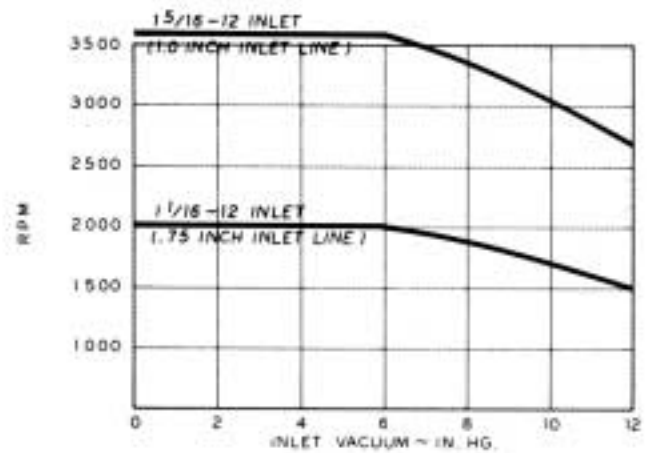

**MODEL 40P007**

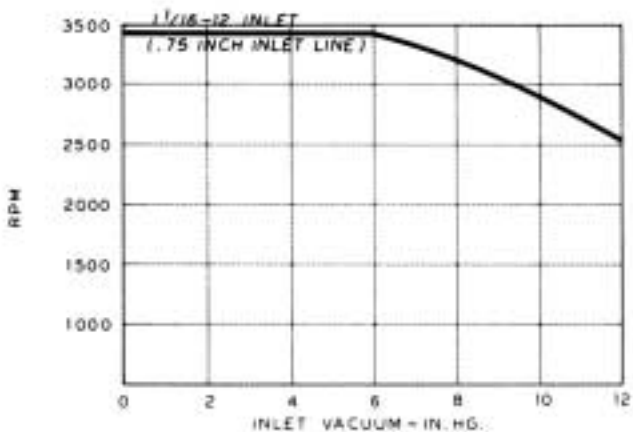

**MODEL 40P015**

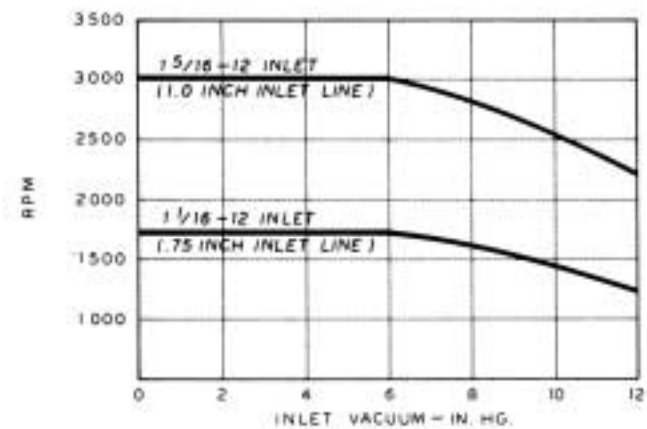

**MODEL 40P010**

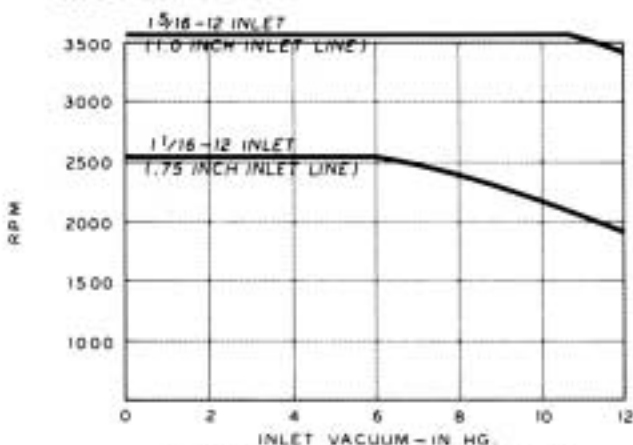

**MODEL 40P018**

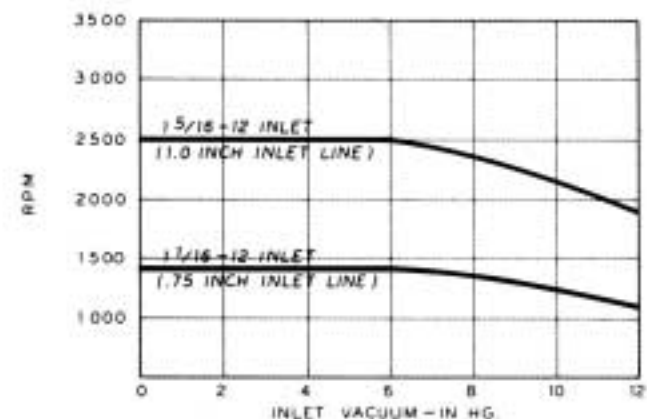

DO NOT operate above the RPM-inlet vacuum curve or 8 in. Hg. for specific inlet port sizes shown.



**CROSS MANUFACTURING, INC.**  
100 Factory Street  
Lewis, Kansas 67552  
620/324-5525 fax -5737