

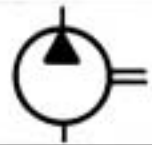

# HYDRAULIC PUMPS

## GEAR PUMPS 50 SERIES Specification Sheet



The CROSS Series 50 gear pumps feature a gear tooth design that provides more displacement within a given package size. Available in 7 sizes, with displacements from 1.52 to 5.20 cubic inches per revolution, this compact pump can deliver up to 45 gallons per minute in a space less than 6 1/4" x 5 1/4" x 7 1/4". Gear tooth design and pressure-balanced loading plates provide high volumetric and overall efficiency while operating at a low noise level.

### GENERAL SPECIFICATIONS

Displacement sizes:

1.52	1.95	2.32	2.74	3.30	3.80	5.20	cu.in./rev.
24.9	32.0	38.0	44.9	54.1	62.3	85.2	cc/rev.

- Rated working pressure (Max. relief valve setting at full flow) . . . . 3000 psi (207 bar)
- Maximum shock and surge pressure . . . . . 3500 psi (242 bar)
- Maximum flow rate (delivery) . . . . . 45 gpm (170 l/m)
- Maximum speed (continuous - see inlet vacuum curves) . . . . . Up to 3000 rpm
- Maximum horsepower (at rated speed and pressure) . . . . . 78 hp (58 kw)
- Mounting (any position) . . . . . SAE "B" size 2-bolt
- Weight . . . . . Approx. 19 lbs. (8.6 kg)

### MATERIAL SPECIFICATIONS

- End covers . . . . . Die cast aluminum alloy
- Gears and Shaft . . . . . Hardened steel
- Bearings . . . . . Pressure lubricated, Teflon impregnated sleeve
- Seals . . . . . Buna N
- Body . . . . . Permold aluminum alloy

### STANDARD FEATURES

- Rotation: Right (clockwise)
- Side location ports: #20 (1 1/4") o-ring inlet (1 5/8 - 12) • #16 (1") o-ring outlet (1 5/16 - 12) • Shaft: 7/8" diameter, woodruff keyed • 20 psi (1.4 bar) shaft seal\*

### OPTIONAL FEATURES AVAILABLE

- Left rotation (counterclockwise) • Bi-rotational (dual rotation) • Rear inlet and outlet port location • SAE #16 (1) o-ring inlet port (1 5/16 - 12) • SAE #20 (1 1/4) o-ring inlet port (1 5/8 - 12) • SAE #24 (1 1/2) o-ring inlet port (1 7/8 - 12)
- Splined shaft, SAE 7/8" dia. (13 tooth 16/32 pitch, 30° PA, flat root side fit, Class I) • Splined shaft, SAE 1" dia. (15 tooth 16/32 pitch, 30° PA, flat root side fit, Class I) • Shaft 7/8" diameter, long (keyed) • Shaft seal, high pressure, 250 psi (17 bar)\*

NOTE: Refer to CROSS pump and motor Technical/Service Sheet for side and end load limitations, oil recommendations and other recommendations.

\* Dual rotation pumps are provided with 250 psi shaft seals.



**DIMENSIONAL DATA: in inches and (millimeters)**

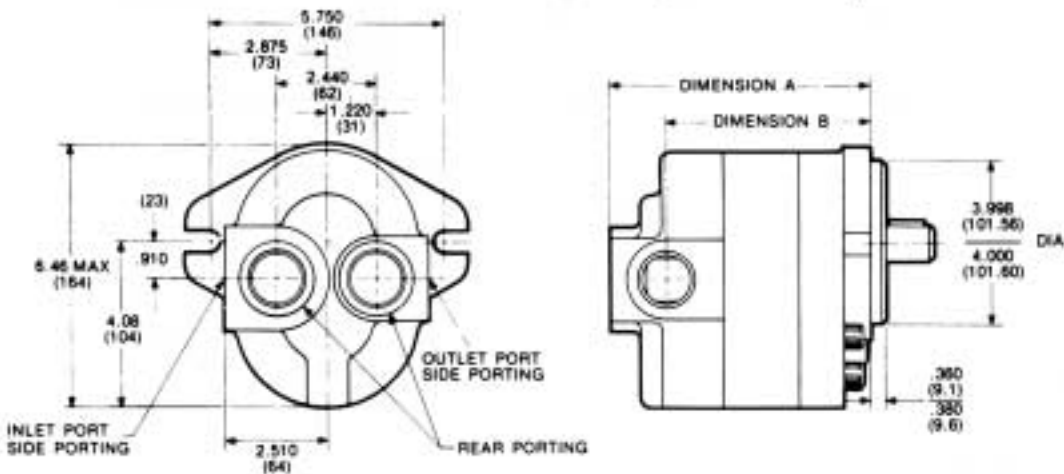

DISPLACEMENT (Cu. In./rev.) (cc/rev.)	1.52 24.9	1.95 32.0	2.32 38.0	2.74 44.9	3.30 54.1	3.80 62.3	5.20 85.2
"A" Dimension (Inches) (mm)	5.60 142.2	5.80 147.3	5.96 151.3	6.15 156.2	6.40 162.6	6.62 168.1	7.21 183.1
"B" Dimension (Inches) (mm)	4.23 107.4	4.43 112.5	4.56 115.8	4.78 121.4	5.03 127.8	5.25 133.3	5.84 148.3

**OUTPUT SHAFT**

<b>SHAFT "A"</b> 13 Tooth, 16/32 pitch; 30° pressure angle; Flat root side fit; Class I.	<b>SHAFT "B"</b> 15 Tooth, 16/32 pitch; 30° pressure angle; Flat root side fit; Class I.	<b>SHAFT "C"</b> Woodruff Key: 1" Diameter x 1/4" wide.	<b>SHAFT "D"</b> Woodruff Key: 1" Diameter x 1/4" wide.
---	---	--	--

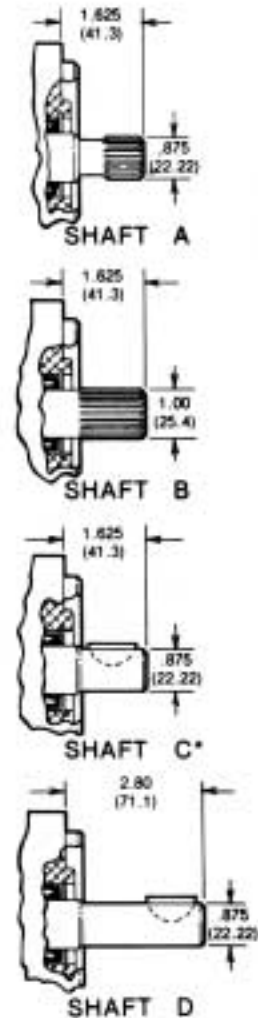

**ORDERING DATA**

Series	Type	Special Options	Size cu.in/R X10	Rotation	Mounting	Shaft Size & Type	Ports Location & Size				
							Inlet	Outlet			
50	P Pump	O None 20 psi Pump Seal H 250 psi Shaft Seal (Standard for dual rotation)	15	D Dual	B SAE "B" 2-Bolt	A 7/8" Dia. Spline	SA	1 7/8	1 5/16	SIDE PORTS	
			19				SB	1 5/8	1 5/16		
			23	L Left Hand	B 1" Dia. Spline	SC	1 5/16	1 5/16			
			27			R Right Hand	C 7/8" Dia. Keyed	RD	1 7/8	1 5/16	REAR PORTS
			33					RE	1 5/8	1 5/16	
			38	RF	1 5/16	1 5/16					
52		D 7/8" Dia. Long Keyed									

EXAMPLE: 50P015RBCSB is a Series 50 pump with a 20 psi shaft seal, 1.52 cu.in./rev. displacement, right hand rotation, SAE "B" 2-bolt mounting, 7/8" keyed shaft and side ports with 1 7/8" inlet and 1 5/16" outlet.



# HYDRAULIC PUMPS

## GEAR PUMPS 50 SERIES

### TYPICAL PERFORMANCE DATA

#### MODEL 50P015

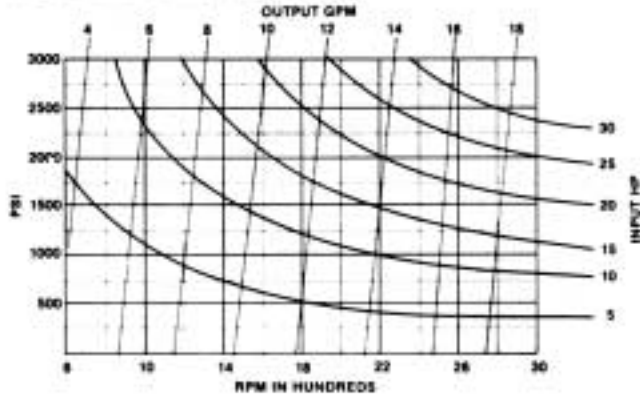

#### MODEL 50P027

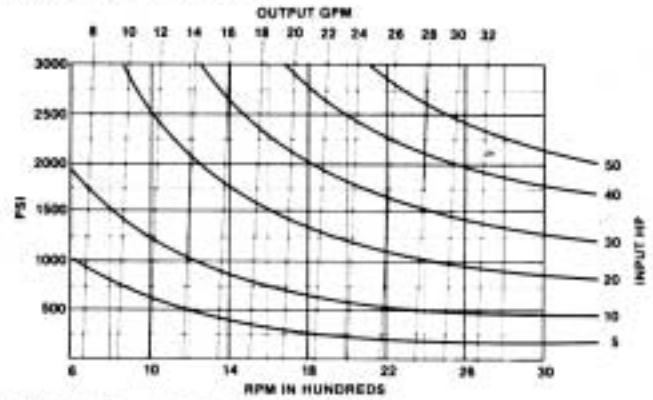

#### MODEL 50P019

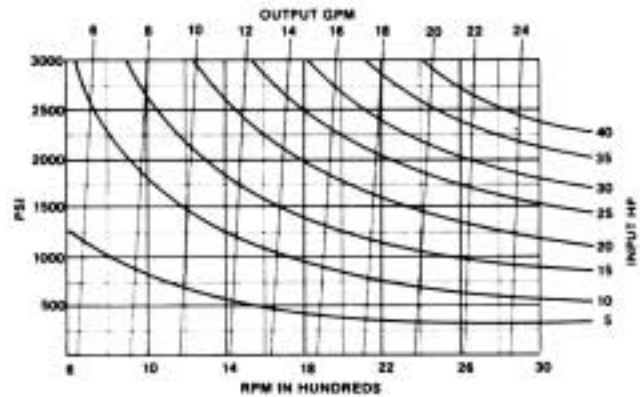

#### MODEL 50P033

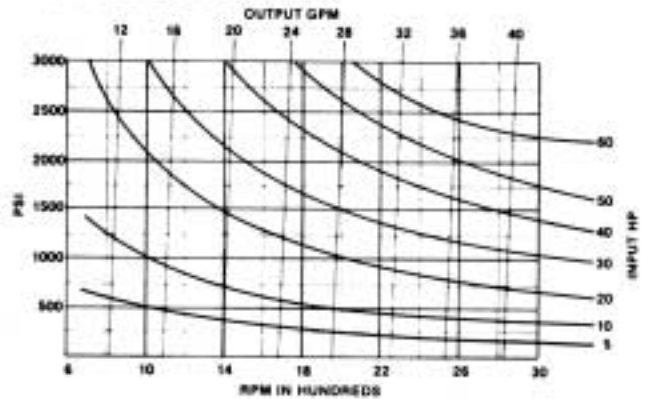

#### MODEL 50P023

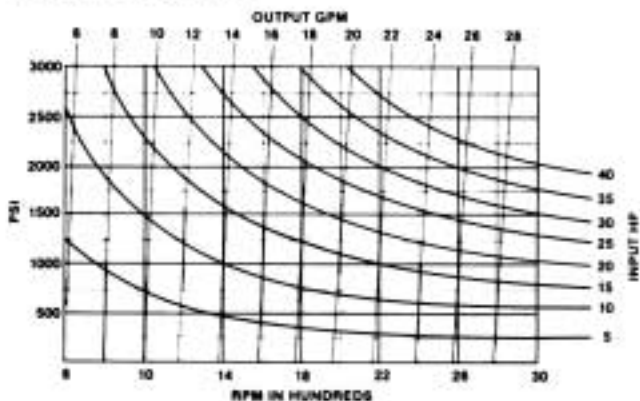

#### MODEL 50P038

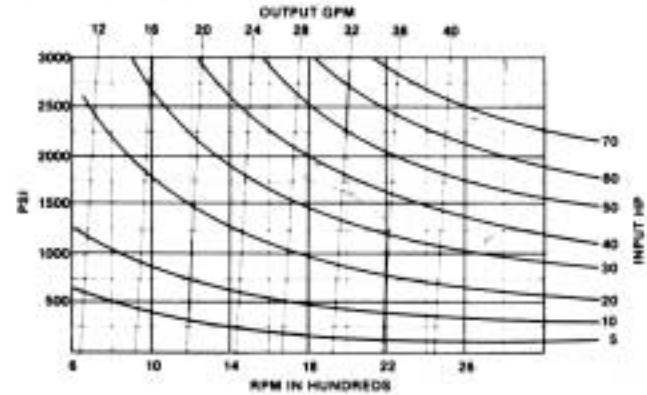

#### MODEL 50P052

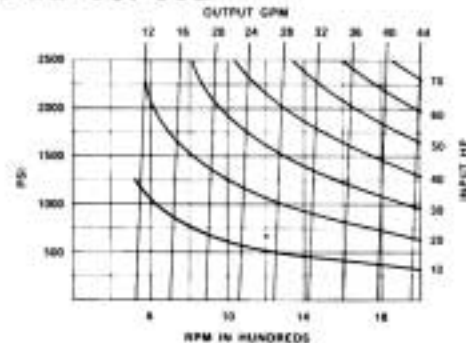



**TYPICAL PERFORMANCE DATA**

**MODEL 50P015**

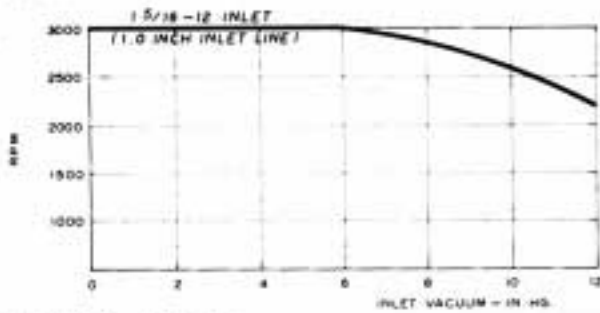

**MODEL 50P033**

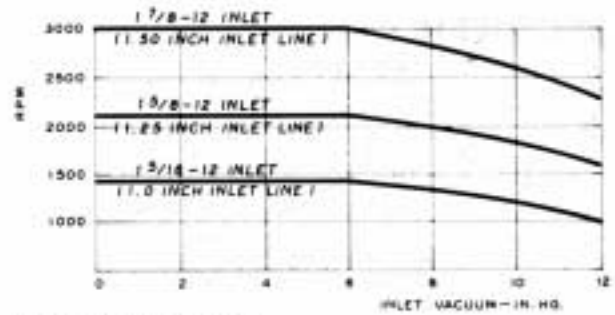

**MODEL 50P019**

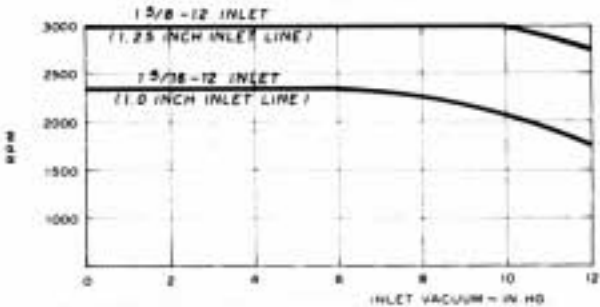

**MODEL 50P038**

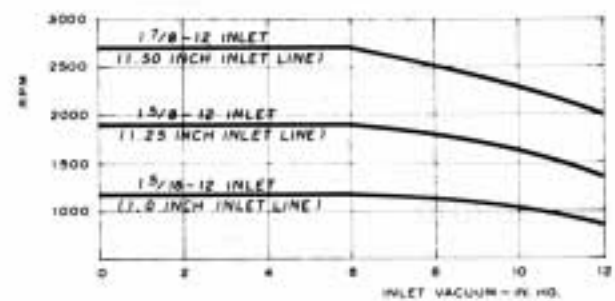

**MODEL 50P023**

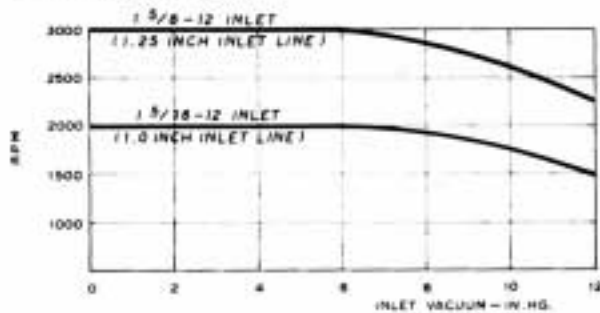

**MODEL 50P052**

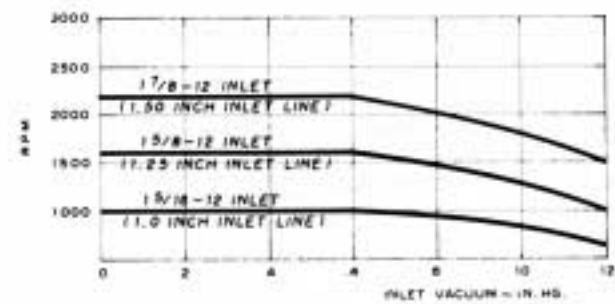

**MODEL 50P027**

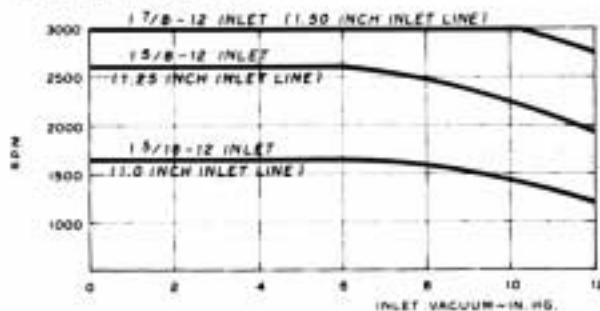

DO NOT operate above the RPM-inlet vacuum curve or 8 in. Hg. for specific inlet sizes shown.



**CROSS MANUFACTURING, INC.**  
100 Factory Street  
Lewis, Kansas 67552  
620/324-5525 fax -5737