

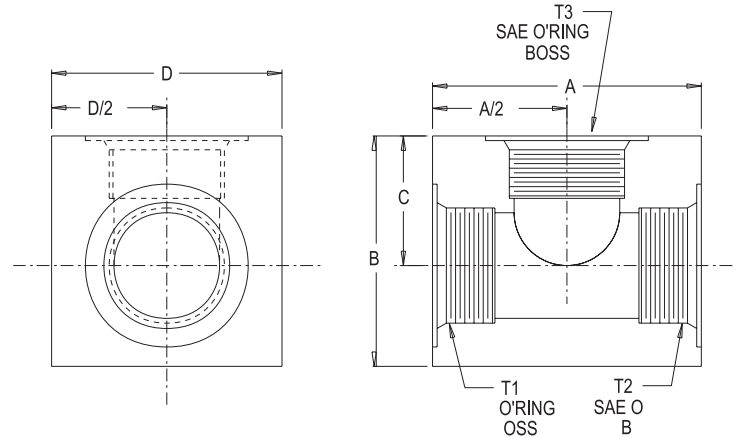

SAE COUPLINGS

SAE Straight Thread Tee

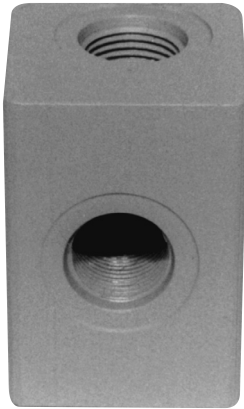

MATERIAL: C1117 C.R.S. Bar

Vescor Part Number	Thread T1	Thread T2	Thread T3	T1 SAE Number	T2 SAE Number	T3 SAE Number	Dimensions			
							A	B	C	D
1040	2½-12	2½-12	2½-12	-32	-32	-32	5.000	4.000	2.187	4.000
1041	2½-12	2½-12	1⅞-12	-32	-32	-24	5.000	3.500	2.000	4.000
1042	2½-12	1⅞-12	2½-12	-32	-24	-32	5.000	4.000	2.187	4.000
1043	2½-12	1⅞-12	1⅞-12	-32	-24	-24	4.125	3.500	2.000	3.500
1044	1⅞-12	1⅞-12	2½-12	-24	-24	-32	4.125	3.500	2.000	3.500
1045	1⅞-12	1⅞-12	1⅞-12	-24	-24	-24	4.125	3.500	2.000	3.500
1046	1⅞-12	1⅞-12	1⅝-12	-24	-24	-20	4.125	3.500	2.000	3.500
1047	1⅞-12	1⅝-12	1⅞-12	-24	-20	-24	4.125	3.500	2.000	3.500
1048	1⅞-12	1⅝-12	1⅝-12	-24	-20	-20	4.125	3.500	2.000	3.500
1049	1⅝-12	1⅝-12	1⅞-12	-20	-20	-24	3.500	2.750	1.625	2.750
1050	1⅝-12	1⅝-12	1⅝-12	-20	-20	-20	3.500	2.750	1.625	2.750
1051	1⅝-12	1⅝-12	1⅝ ₁₆ -12	-20	-20	-16	3.500	2.750	1.625	2.750
1052	1⅝-12	1⅝ ₁₆ -12	1⅝-12	-20	-16	-20	3.500	2.750	1.625	2.750
1053	1⅝-12	1⅝ ₁₆ -12	1⅝ ₁₆ -12	-20	-16	-16	3.500	2.750	1.625	2.750
1054	1⅝ ₁₆ -12	1⅝ ₁₆ -12	1⅝-12	-16	-16	-20	3.250	2.500	1.500	2.500
1055	1⅝ ₁₆ -12	1⅝ ₁₆ -12	1⅝ ₁₆ -12	-16	-16	-16	3.250	2.500	1.500	2.500
1056	1⅝ ₁₆ -12	1⅝ ₁₆ -12	1⅝ ₁₆ -12	-16	-16	-12	3.250	2.500	1.500	2.500
1057	1⅝ ₁₆ -12	1⅝ ₁₆ -12	1⅝ ₁₆ -12	-16	-12	-16	3.250	2.500	1.500	2.500
1058	1⅝ ₁₆ -12	1⅝ ₁₆ -12	1⅝ ₁₆ -12	-16	-12	-12	3.250	2.500	1.500	2.500
1059	1⅝ ₁₆ -12	1⅝ ₁₆ -12	1⅝ ₁₆ -12	-12	-12	-16	3.000	2.125	1.312	2.125
1060	1⅝ ₁₆ -12	1⅝ ₁₆ -12	1⅝ ₁₆ -12	-12	-12	-12	3.000	2.125	1.312	2.125
1061	1⅝ ₁₆ -12	1⅝ ₁₆ -12	⅞-14	-12	-12	-10	3.000	2.125	1.312	2.125
1062	1⅝ ₁₆ -12	⅞-14	⅞-14	-12	-10	-12	3.000	2.125	1.312	2.125
1063	1⅝ ₁₆ -12	⅞-14	⅞-14	-12	-10	-10	3.000	2.125	1.312	2.125
1064	⅞-14	1⅝ ₁₆ -12	⅞-14	-10	-12	-10	2.875	2.000	1.312	2.000
1065	⅞-14	⅞-14	⅞-14	-10	-10	-10	2.875	2.000	1.312	2.000
1066	⅞-14	⅞-14	¾-16	-10	-10	-8	2.875	2.000	1.312	2.000
1067	⅞-14	¾-16	⅞-14	-10	-8	-10	2.875	2.000	1.312	2.000
1068	⅞-14	¾-16	¾-16	-10	-8	-8	2.875	2.000	1.312	2.000
1069	¾-16	¾-16	⅞-14	-8	-8	-10	2.625	1.750	1.125	1.750
1070	¾-16	¾-16	¾-16	-8	-8	-8	2.625	1.750	1.125	1.750
1071	¾-16	¾-16	⅞ ₁₆ -18	-8	-8	-6	2.625	1.750	1.125	1.750
1072	¾-16	⅞ ₁₆ -18	¾-16	-8	-6	-8	2.625	1.750	1.125	1.750
1073	¾-16	⅞ ₁₆ -18	⅞ ₁₆ -18	-8	-6	-6	2.625	1.750	1.125	1.750
1074	⅞ ₁₆ -18	⅞ ₁₆ -18	⅞-14	-6	-6	-10	2.625	1.750	1.125	1.750
1075	⅞ ₁₆ -18	⅞ ₁₆ -18	⅞ ₁₆ -18	-6	-6	-6	2.625	1.750	1.125	1.750



SAE COUPLINGS

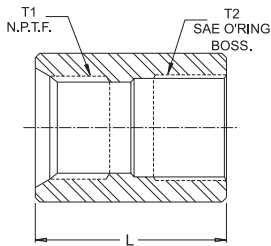
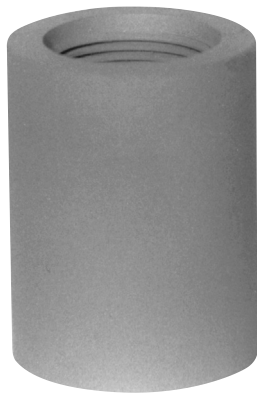

SAE/NPT COUPLING

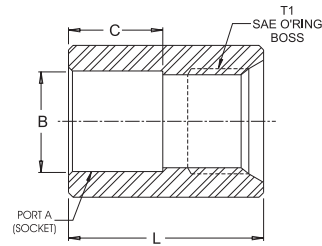
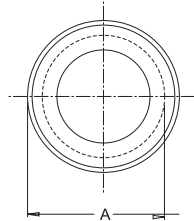

SAE/SOCKET WELD COUPLING

SAE / NPT Full Couplings

MATERIAL: Steel-ASTM A-105, Stainless Steel-Grade 316

Vescor Steel Part Number	Vescor Stainless Steel Part Number	L Length	A Diameter	Thread T1	Nominal Pipe Size	Thread T2	T2 SAE Number
1000	11600	1.875	1.125	1/2-14 N.P.T.F.	1/2"	9/16-18 UNF-2B	-6
1001	11601	1.875	1.125	1/2-14 N.P.T.F.	1/2"	3/4-16 UNF-2B	-8
1002	11602	2.000	1.375	3/4-14 N.P.T.F.	3/4"	7/8-14 UNF-2B	-10
1003	11603	2.000	1.375	3/4-14 N.P.T.F.	3/4"	1 1/16-12 UNF-2B	-12
1004	11604	2.375	1.750	1-11 1/2 N.P.T.F.	1"	1 3/16-12 UNF-2B	-14
1005	11605	2.375	1.750	1-11 1/2 N.P.T.F.	1"	1 5/16-12 UNF-2B	-16
1006	11606	2.625	2.250	1 1/4-11 1/2 N.P.T.F.	1 1/4"	1 5/8-12 UNF-2B	-20
1007	11607	3.000	2.500	1 1/2-11 1/2 N.P.T.F.	1 1/2"	1 7/8-12 UNF-2B	-24
1008	11608	3.375	3.000	2-11 1/2 N.P.T.F.	2"	2 1/2-12 UNF-2B	-32

SAE / Socket Weld Full Couplings

MATERIAL: Steel-ASTM A-105, Stainless Steel-Grade 316

Vescor Steel Part Number	Vescor Stainless Steel Part Number	L Length	A Diameter	Thread T1	T1 SAE Number	Port A Socket For Pipe Size	Dimensions B	C
1080	11680	1.875	1.125	9/16-18 UNF-2B	-6	1/2" Pipe	.855	.625
1081	11681	1.875	1.125	3/4-16 UNF-2B	-8	1/2" Pipe	.855	.625
1082	11682	2.000	1.375	7/8-14 UNF-2B	-10	3/4" Pipe	1.065	.750
1083	11683	2.000	1.375	1 1/16-12 UNF-2B	-12	3/4" Pipe	1.065	.750
1084	11684	2.375	1.750	1 3/16-12 UNF-2B	-14	1" Pipe	1.330	1.000
1085	11685	2.375	1.750	1 5/16-12 UNF-2B	-16	1" Pipe	1.330	1.000
1086	11686	2.625	2.250	1 5/8-12 UNF-2B	-20	1 1/4" Pipe	1.675	1.000
1087	11687	3.000	2.500	1 7/8-12 UNF-2B	-24	1 1/2" Pipe	1.915	1.000
1088	11688	3.375	3.250	2 1/2-12 UNF-2B	-32	2" Pipe	2.406	1.250

NOTE: WITH VESCORS' POLICY OF CONSTANTLY IMPROVING ITS PRODUCTS, SPECIFICATIONS ARE SUBJECT TO CHANGE WITHOUT NOTICE.



SAE COUPLINGS

SAE O'Ring Boss Full Couplings

MATERIAL: C1117 C.R.S. Bar

Vescor Part Number	L Length	A Diameter	Thread T1	T1 SAE Number	Thread T2	T2 SAE Number
1020	1.500	.875	7/16-20 UNF-2B	-4	7/16-20 UNF-2B	-4
1021	1.375	1.000	9/16-18 UNF-2B	-6	9/16-18 UNF-2B	-6
1022	1.500	1.250	3/4-16 UNF-2B	-8	3/4-16 UNF-2B	-8
1023	1.750	1.500	7/8-14 UNF-2B	-10	7/8-14 UNF-2B	-10
1024	2.000	1.625	1 1/16-12 UNF-2B	-12	1 1/16-12 UNF-2B	-12
1025	2.000	2.000	1 3/16-12 UNF-2B	-14	1 3/16-12 UNF-2B	-14
1026	2.000	2.000	1 5/16-12 UNF-2B	-16	1 5/16-12 UNF-2B	-16
1027	2.500	2.500	1 5/8-12 UNF-2B	-20	1 5/8-12 UNF-2B	-20
1028	2.500	2.500	1 7/8-12 UNF-2B	-24	1 7/8-12 UNF-2B	-24
1029	2.750	3.250	2 1/2-12 UNF-2B	-32	2 1/2-12 UNF-2B	-32
1030	1.500	1.250	3/4-16 UNF-2B	-8	9/16-18 UNF-2B	-6
1031	1.750	1.500	7/8-14 UNF-2B	-10	3/4-16 UNF-2B	-8
1032	2.000	1.625	1 1/16-12 UNF-2B	-12	7/8-14 UNF-2B	-10
1033	2.000	2.000	1 5/16-12 UNF-2B	-16	1 1/16-12 UNF-2B	-12
1034	2.500	2.500	1 5/8-12 UNF-2B	-20	1 5/16-12 UNF-2B	-16
1035	2.500	2.500	1 7/8-12 UNF-2B	-24	1 5/8-12 UNF-2B	-20
1036	2.000	1.625	1 1/16-12 UNF-2B	-12	3/4-16 UNF-2B	-8
1037	2.750	3.500	2 1/2-12 UNF-2B	-32	1 7/8-12 UNF-2B	-24

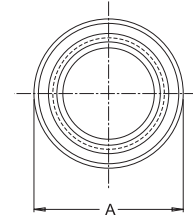
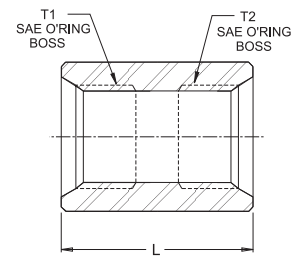

SAE Half Couplings

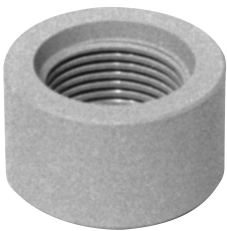

MATERIAL: Steel-C1117 C.R.S. Bar, Stainless Steel-Grade 316

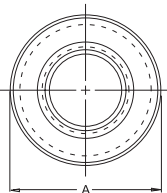
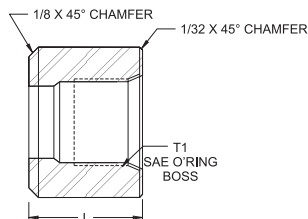

Vescor Steel Part Number	Vescor Stainless Steel Part Number	L Length	A Diameter	Thread T1	T1 SAE Number
V-6206	V-8906	.750	.875	7/16-20 UNF-2B	-4
V-6207	V-8907	.750	1.000	1/2-20 UNF-2B	-5
V-6208	V-8908	.750	1.000	9/16-18 UNF-2B	-6
V-6209	V-8909	.750	1.250	3/4-16 UNF-2B	-8
V-6210	V-8910	.875	1.500	7/8-14 UNF-2B	-10
V-6211	V-8911	1.000	1.625	1 1/16-12 UNF-2B	-12
V-6212	V-8912	1.000	2.000	1 3/16-12 UNF-2B	-14
V-6213	V-8913	1.250	2.000	1 5/16-12 UNF-2B	-16
V-6214	V-8914	1.250	2.500	1 5/8-12 UNF-2B	-20
V-6215	V-8915	1.250	2.500	1 7/8-12 UNF-2B	-24
V-6216	V-8916	1.375	3.250	2 1/2-12 UNF-2B	-32